

www.beargrip.com



BEARGRIP®

Inbusové kľúče

Inbusové kľúče s guľičkou

Torx kľúče

Skrutkovače

Bity

Nitovacie kliešte

Nity

Made in Slovakia



Vážení naši zákazníci,

chceme Vám predstaviť produkty firmy BEARGRIP, pôvodne z Holandska, ktoré dnes, ako jeden z mála výrobcov ručných nástrojov na Slovensku, vyrábame práve my, spoločnosť Triumf professional tools s.r.o.. Nie je to bežné, aby práve slovenská spoločnosť kúpila holandskú firmu.

Firma BEARGRIP bola pôvodne založená v roku 1956 ako importér náradia z Ázie do Holandska. Kvalita náradia však nevyhovovala náročným požiadavkám jej klientov. Stalo sa tak už po prvej dodávke inbusových kľúčov. Majiteľ sa preto rozhodol, že spolu s rovnako zmýšľajúcimi priateľmi nástroje začne vyrábať sám.

Neveľká skupina nadšencov sa pustila do projektovania a od roku 1957 do roku 2002 vyrábali inbusové kľúče, rôzne prevedenia T-kľúčov a skrutkovačov, skrutkovacích hrotov balených v bit-blok kockách a zaklápacích kľúčov v rôznych prevedeniach. Samozrejme v takej kvalite, že nástroje firmy BEARGRIP začali byť známe aj u "fajnšmekrov". Dokonca nitovacie kliešte preslávili firmu kvalitou na celom svete. V čase najväčšej expanzie produkovala firma BEARGRIP 5 000 kusov klieští modelu 802 mesačne. Tieto kliešte nájdete na všetkých kontinentoch.

Postupne sa menej inovovalo a firma BEARGRIP sa zmenšovala. Proces to nebol ľahký, od výmeny majiteľov v roku 2002 až do 2013, keď nakoniec bola v auguste ponúknutá na predaj. Ako dlhoročný zákazník holandského špecialistu na náradie, sme sa rozhodli využiť túto možnosť. A tak sa firma BEARGRIP stala súčasťou slovenskej spoločnosti Triumf professional tools s.r.o. Nebolo jednoduché prevziať výrobu, ale už v septembri 2013 sme vyslali prvú skupinu pracovníkov na zaškolenie, do už našej firmy BEARGRIP, do Holandska. Začiatkom januára 2014 bolo takmer všetko presťahované do Martina, kde naša spoločnosť sídli, a mohli sme začať s výrobou technológiami, ktoré sú zárukou kvality.

Tieto výrobky ponúkame v atraktívnom balení aj Vám za prijateľné ceny. V Triumfe sa snažíme minimalizovať časové straty medzi nápadom a realizáciou, o čom svedčí čoraz širší sortiment vlastných výrobkov a inovácií.

Na slovenský trh Vám prinášame produkty svetovej kvality BEARGRIP overené desiatkami rokov a tisíckami rúk. Pokračuje nielen v domácom predaji, ale aj v exporte pre zákazníkov do 4 kontinentov, ktorí si na náradie BEARGRIP zvykli a nevedia si ho vynachváliť.

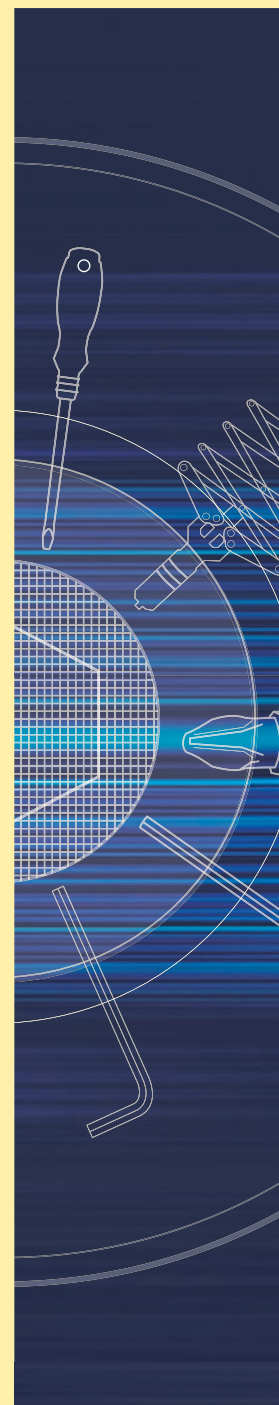

Beargrip s.r.o.

Kollárova 88

03601 Martin

Slovakia

T: +421 434 003 605

F: +421 434 003 604

E: mail@beargrip.com

I: www.beargrip.com

MM = 2200



INBUSOVÉ KĹÚČE, POVRCHOVÁ ÚPRAVA ČIERNENIE
ISO 2936 (DIN 911), 54°-56°HRC

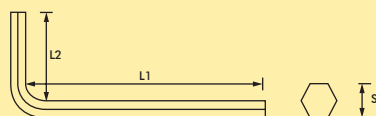

2200 mm	obj. kód balenie PE sáčok	obj. kód balenie blister	S max mm	S min mm	L1 mm	L2 mm
0,7	30812	-	0,711	0,698	32	6
0,9	30813	-	0,889	0,876	32	10
1	30814	-	0,989	0,976	32	10
1,3	30815	-	1,270	1,244	40	12
1,5	30816	32617	1,500	1,475	45	14
2	30817	32511	2,000	1,960	50	16
2,5	30818	32618	2,500	2,460	56	18
3	30819	32512	3,000	2,960	63	20
3,5	30820	32513	3,500	3,480	63	21
4	30821	32514	4,000	3,952	70	25
4,5	30822	32515	4,500	4,470	73	25
5	30823	32516	5,000	4,952	80	28
5,5	30824	32517	5,500	5,450	80	29
6	30825	32518	6,000	5,952	90	32
7	30826	32519	7,000	6,942	95	34
8	30827	32520	8,000	7,942	100	36
9	30828	32619	9,000	8,942	106	38
10	30829	32521	10,000	9,942	112	40
11	30830	32620	11,000	10,942	120	42
12	30831	32522	12,000	11,890	125	45
13	30832	32523	13,000	12,890	133	50
14	30833	32621	14,000	13,890	140	56
16	33504	-	16,000	15,890	148	58
17	30834	-	17,000	16,890	160	63
19	30835	-	19,000	18,870	180	70
21	33411	-	21,000	20,870	185	74
22	30836	-	22,000	21,870	200	80
24	30837	-	24,000	23,870	224	90
27	30838	-	27,000	26,870	250	100
30	30839	-	30,000	29,890	272	110
32	30840	-	32,000	31,890	315	125
36	30841	-	36,000	35,890	355	140
41	30842	-	41,000	40,960	401	153
46	30843	-	46,000	45,960	444	166
50	30844	-	50,000	49,960	476	184

32598 Plechový stojan pre inbusy, naplnený 18 ks

INBUSOVÉ KĹÚČE

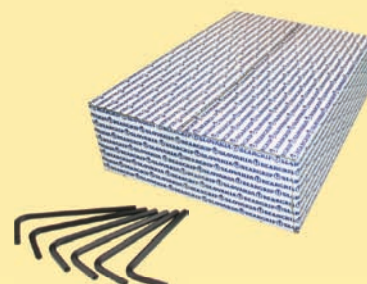

32598 veľkosti pozri na str. 9

INCH = 1200

INBUSOVÉ KLÚČE, POVRCHOVÁ ÚPRAVA ČIERNENIE
BS 2470, 54°-56°HRc

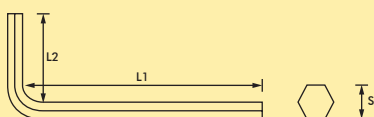

1200 inch	obj. kód balenie PE sáčok	obj. kód balenie blister	S max inch	S min inch	L1 inch	L2 inch
0,028	31555	-	0,0280	0,0275	1,313	0,313
0,035	31556	-	0,3500	0,0345	1,313	0,438
0,050	31577	-	0,0500	0,0490	1,750	0,625
1/16	31558	32819	0,0625	0,0615	1,772	0,551
5/64	31559	32820	0,0781	0,0771	1,969	0,630
3/32	31560	32821	0,0937	0,0927	2,205	0,709
7/64	31561	32822	0,1094	0,1079	2,244	0,748
1/8	31562	32823	0,1250	0,1235	2,480	0,787
9/64	31563	32824	0,1406	0,1391	2,441	0,866
5/32	31564	32825	0,1562	0,1547	2,756	0,984
3/16	31565	32826	0,1875	0,1860	3,150	1,102
7/32	31566	32827	0,2187	0,2172	3,543	1,260
1/4	31567	32828	0,2500	0,2485	3,543	1,299
9/32	31568	-	0,2812	0,2797	3,740	1,093
5/16	31569	32829	0,3125	0,3110	3,937	1,417
3/8	31570	32832	0,3750	0,3735	4,409	1,575
7/16	31571	32833	0,4375	0,4355	4,844	1,594
1/2	31572	32834	0,5000	0,4975	4,921	1,772
9/16	31573	-	0,5625	0,5600	5,844	1,844
5/8	31574	-	0,6250	0,6225	6,344	1,969
3/4	31575	-	0,7500	0,7470	7,344	2,219
7/8	31576	-	0,8750	0,8720	8,344	2,469
1	31577	-	1,0000	0,9970	9,344	2,719

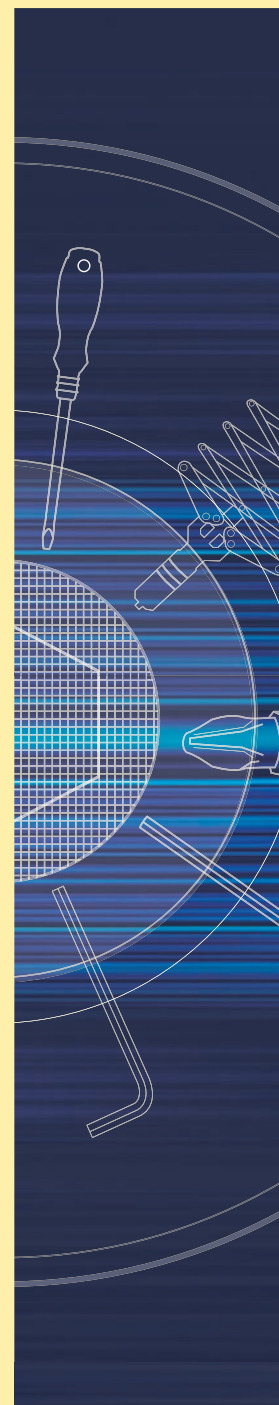

Beargrip s.r.o.
Kollárova 88
03601 Martin
Slovakia
T: +421 434 003 605
F: +421 434 003 604
E: mail@beargrip.com
I: www.beargrip.com

MM INCH INBUSOVÉ KLÚČE, POVRCHOVÁ ÚPRAVA ČIERNENIE
ISO 2936 (DIN 911), 54°-56°HRc, BS 2470, 54°-56°HRc



⊙ = 2246

SADY V SKLÁPACOM DRŽIAKU NA BLISTRI

obj. kód	⊙	velkosti	ks
30438	mm	1,5 - 2 - 2,5 - 3 - 4 - 5 - 6 - 8 - 10	9
34603	mm	1,5 - 2 - 2,5 - 3 - 4 - 5 - 6 - 8 - 10 - 12	10

⊙ = 1246

obj. kód	⊙	velkosti	ks
30437	inch	1/16 - 5/64 - 3/32 - 1/8 - 5/32 - 3/16 - 1/4 - 5/16 - 3/8"	9



SADA V PEVNOM DRŽIAKU NA BLISTRI

⊙ = 2243

obj. kód	⊙	velkosti	ks
34482	mm	2 - 2,5 - 3 - 4 - 5 - 6 - 8 - 10	8



INBUSOVÉ KLÚČE

MM INCH INBUSOVÉ KLÚČE, POVRCHOVÁ ÚPRAVA ČIERNENIE
ISO 2936 (DIN 911), 54°-56°HRC, BS 2470, 54°-56°HRC

SADA NA KRÚŽKU NA BLISTRI

○ = 2213	obj. kód	○	veľkosti	ks
	31578	mm	1,5 - 2 - 2,5 - 3 - 4 - 5 - 6 - 8 - 10	9
○ = 2221	31579	mm	2 - 2,5 - 3 - 4 - 5 - 6	6

○ = 1213	obj. kód	○	veľkosti	ks
	31585	inch	1/16 - 5/64 - 3/32 - 1/8 - 5/32	10
			3/16 - 7/32 - 1/4 - 5/16 - 3/8"	
○ = 1220	31586	inch	1/16 - 5/64 - 3/32 - 1/8 - 5/32	8
			3/16 - 7/32 - 1/4"	



30519 Reklamný kartónový stojan pre sady inbusových kľúčov na blistroch



Beargrip s.r.o.
Kollárova 88
03601 Martin
Slovakia
T: +421 434 003 605
F: +421 434 003 604
E: mail@beargrip.com
I: www.beargrip.com

MM INCH INBUSOVÉ KLÚČE, POVRCHOVÁ ÚPRAVA ČIERNENIE
ISO 2936 (DIN 911), 54°-56°HRc, BS 2470, 54°-56°HRc



⊙ = 2229

SADA V GUMENOM PÚZDRE

obj. kód	⊙	veľkosti	ks
31580	mm	1,5 - 2 - 2,5 - 3 - 4 - 5 - 6 - 8 10 - 12	10

⊙ = 1229

obj. kód	⊙	veľkosti	ks
31587	inch	1/16 - 5/64 - 3/32 - 1/8 - 5/32 3/16 - 7/32 - 5/16 - 3/8 - 1/2"	10



DREVENÁ PREZENTAČNÁ KAZETA INBUSOVÝCH KLÚČOV

MM

INCH

⊙ = 2260

séria	obj. kód balenie PE sáčok	⊙ mm	ks
2200	30814	1	50
2200	30816	1,5	50
2200	30817	2	50
2200	30818	2,5	50
2200	30819	3	50
2200	30821	4	50
2200	30823	5	50
2200	30825	6	50
2200	30826	7	10
2200	30827	8	25
2200	30828	9	10
2200	30829	10	25

⊙ = 1260

séria	obj. kód balenie PE sáčok	⊙ inch	ks
1200	31558	1/16	50
1200	31559	5/64	50
1200	31560	3/32	50
1200	31561	7/64	50
1200	31562	1/8	50
1200	31563	9/64	25
1200	31564	5/32	25
1200	31565	3/16	50
1200	31566	7/32	25
1200	31567	1/4	50
1200	31568	9/32	10
1200	31569	5/16	10
1200	31570	3/8	25

2260 31219 plná - 470ks

1260 31590 plná - 470ks

2260 32427 prázdna

1260 32427 prázdna



INBUSOVÉ KLÚČE

MM = 2400XL INBUSOVÉ KLÚČE EXTRA DLHÉ, POVRCHOVÁ ÚPRAVA ČIERNENIE ISO 2936L (DIN 911L), 54°-56°HRC

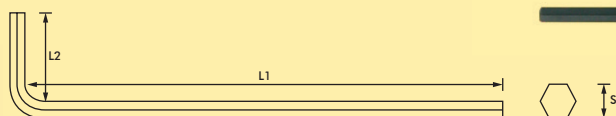

2400 XL mm	obj. kód balenie PE sáčok	obj. kód balenie blister	S max mm	S min mm	L1 mm	L2 mm
0,7	34266	-	0,700	0,652	64	6
0,9	34268	-	0,900	0,852	64	11
1,27	34269	-	1,270	1,230	80	13
1,5	30845	32622	1,500	1,475	90	14
2	30846	32623	2,000	1,960	100	16
2,5	30847	32624	2,500	2,460	112	18
3	30848	32625	3,000	2,960	126	20
4	30849	32626	4,000	3,952	140	25
5	30850	32627	5,000	4,952	160	28
6	30851	32628	6,000	5,952	180	32
7	30852	32629	7,000	6,942	190	34
8	30853	32630	8,000	7,942	200	36
9	30854	32631	9,000	8,942	212	38
10	30855	32632	10,000	9,942	224	40
11	30856	32633	11,000	10,942	240	42
12	30857	32634	12,000	11,890	250	45
13	30858	-	13,000	12,890	266	50
14	30859	-	14,000	13,890	280	56
16	31667	-	16,000	16,110	285	57
17	30860	-	17,000	16,890	320	63
19	30861	-	19,000	18,870	360	70
21	31668	-	21,000	20,960	381	77
22	31669	-	22,000	21,960	397	80
24	31670	-	24,000	23,960	440	88
27	31671	-	27,000	26,960	492	102

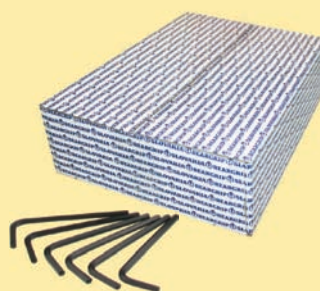

DREVENÁ PREZENTAČNÁ KAZETA EXTRA DLHÝCH INBUSOVÝCH KLÚČOV MM

○ = 2460XL

séria	obj. kód balenie PE sáčok	○ mm	ks
2400XL	30845	1,5	30
2400XL	30846	2	40
2400XL	30847	2,5	40
2400XL	30848	3	40
2400XL	30849	4	20
2400XL	30850	5	10
2400XL	30851	6	20
2400XL	30852	7	10
2400XL	30853	8	10
2400XL	30854	9	10
2400XL	30855	10	10

2460XL 31265 plná - 240ks
2460XL 34479 prázdna



Beargrip s.r.o.
Kollárova 88
03601 Martin
Slovakia
T: +421 434 003 605
F: +421 434 003 604
E: mail@beargrip.com
I: www.beargrip.com

INCH = 1400XL INBUSOVÉ KLÚČE EXTRA DLHÉ, POVRCHOVÁ ÚPRAVA ČIERNENIE BS 2470L, 54°-56°HRc

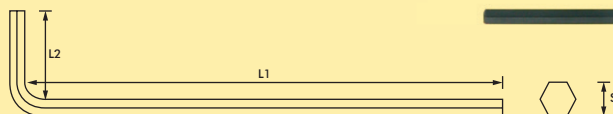

1400 XL inch	obj. kód balenie PE sáčok	obj. kód balenie blister	S max inch	S min inch	L1 inch	L2 inch
1/16	31672	-	0,0625	0,0615	3,504	0,551
5/64	31673	-	0,0781	0,0771	3,937	0,630
3/32	31674	-	0,0937	0,0927	4,370	0,709
7/64	31675	-	0,1094	0,1079	4,646	0,748
1/8	31676	-	0,1250	0,1235	4,921	0,787
9/64	31677	-	0,1406	0,1391	5,236	0,866
5/32	31678	-	0,1562	0,1547	5,551	0,984
3/16	31679	-	0,1875	0,1860	6,299	1,102
7/32	31680	-	0,2187	0,2172	7,126	1,260
1/4	31681	-	0,2500	0,2485	7,520	1,299
9/32	31229	-	0,2812	0,2797	7,323	1,093
5/16	31682	-	0,3125	0,3110	7,756	1,417
3/8	31683	-	0,3750	0,3735	8,386	1,575
7/16	31684	-	0,4375	0,4355	8,594	1,594
1/2	31685	-	0,5000	0,4975	9,094	1,772
9/16	31686	-	0,5625	0,5600	9,094	1,844
5/8	31687	-	0,6250	0,6225	9,844	1,969
3/4	31688	-	0,7500	0,7470	11,344	2,219

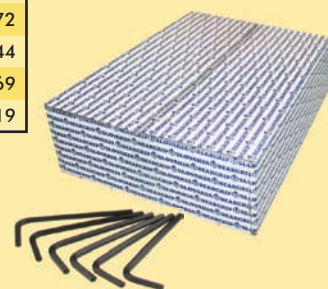

PLECHOVÝ STOJAN PRE INBUSY MM



séria	obj. kód	mm	ks
2200	30831	12	2
2200	30833	14	2
2200	30834	17	2
2200	30835	19	1
2200	30836	22	1
2200	30837	24	1
2400XL	30857	12	2
2400XL	30859	14	2
2400XL	30860	17	2
2400XL	30861	19	1
2400XL	31669	22	1
2400XL	31670	24	1

2200 a 2400XL 32598 plný - 18ks
2200 a 2400XL 32473 prázdny

INBUSOVÉ KLÚČE

MM
INCH

INBUSOVÉ KLÚČE EXTRA DLHÉ, POVRCHOVÁ ÚPRAVA ČIERNENIE
ISO 2936L (DIN 911L), 54°-56°HRc, BS 2470L, 54°-56°HRc

SADA V SKLÁPACOM DRŽIAKU NA BLISTRI

○ = 2446

obj. kód	○	velkosti	ks
30439	mm	1,5 - 2 - 2,5 - 3 - 4 - 5 - 6 - 8 - 10	9
34604	mm	1,5 - 2 - 2,5 - 3 - 4 - 5 - 6 - 8	10
		10 - 12	

○ = 1446

obj. kód	○	velkosti	ks
30440	inch	1/16 - 5/64 - 3-32 - 1/8 - 5/32	9
		3/16 - 1/4 - 5/16 - 3/8"	



SADA NA KRÚŽKU NA BLISTRI

○ = 2429

obj. kód	○	velkosti	ks
34480	mm	2 - 2,5 - 3 - 4 - 5 - 6 - 8 - 10	8

○ = 1429

obj. kód	○	velkosti	ks
34481	inch	5/64 - 3-32 - 1/8 - 5/32 - 3/16	9
		7/32 - 1/4 - 5/16 - 3/8"	



Beargrip s.r.o.
Kollárova 88
03601 Martin
Slovakia
T: +421 434 003 605
F: +421 434 003 604
E: mail@beargrip.com
I: www.beargrip.com

MM = 2311L INBUSOVÉ KLÚČE S GULIČKOU DLHÉ,
POVRCHOVÁ ÚPRAVA ČIERNENIE
ISO 2936 (DIN 911), 54°-56°HRc

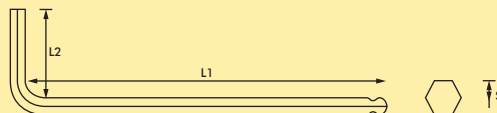

2311 mm	obj. kód balenie PE sáčok	obj. kód balenie blister	S max mm	S min mm	L1 mm	L2 mm
1,5	31717	32636	1,500	1,475	68	14
2	31718	32637	2,000	1,960	75	16
2,5	31719	32638	2,500	2,460	85	18
3	31720	32639	3,000	2,960	95	20
4	31721	32640	4,000	3,952	106	25
5	31722	32641	5,000	4,952	120	28
6	31723	32642	6,000	5,952	135	32
7	31724	32643	7,000	6,942	140	34
8	31725	32644	8,000	7,942	149	36
9	31726	32645	9,000	8,942	157	38
10	31727	32646	10,000	9,942	168	40
12	31728	32647	12,000	11,890	190	45

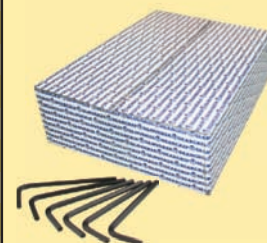

INCH = 1311L INBUSOVÉ KLÚČE S GULIČKOU DLHÉ,
POVRCHOVÁ ÚPRAVA ČIERNENIE
BS 2470L, 54°-56°HRc

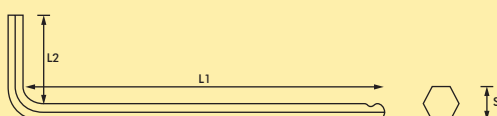

1311 inch	obj. kód balenie PE sáčok	obj. kód balenie blister	S max inch	S min inch	L1 inch	L2 inch
0,050	31729	-	0,0500	0,0490	2,461	0,492
1/16	31730	-	0,0625	0,0615	2,677	0,551
5/64	31731	-	0,0781	0,0771	3,937	0,630
3/32	31732	-	0,0937	0,0927	4,370	0,709
7/64	31733	-	0,1094	0,1079	4,646	0,748
1/8	31734	-	0,1250	0,1235	4,921	0,787
9/64	31735	-	0,1406	0,1391	5,236	0,866
5/32	31736	-	0,1562	0,1547	5,551	0,984
3/16	31737	-	0,1875	0,1860	6,299	1,102
7/32	31738	-	0,2187	0,2172	7,126	1,260
1/4	31739	-	0,2500	0,2485	7,520	1,299
5/16	31740	-	0,3125	0,3110	7,756	1,417
3/8	31741	-	0,3750	0,3735	8,386	1,575



INBUSOVÉ KLÚČE

MM = 2311XL INBUSOVÉ KLÚČE S GULIČKOU EXTRA DLHÉ,
POVRCHOVÁ ÚPRAVA ČIERNENIE
ISO 2936 (DIN 911), 54°-56°HRc

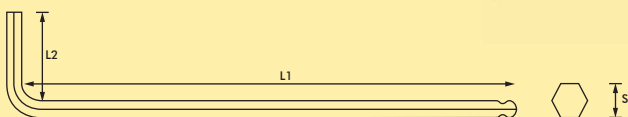

2311 XL mm	obj. kód balenie v PE sáčok	S max mm	S min mm	L1 mm	L2 mm
1,5	31744	1,500	1,475	90	14
2	31745	2,000	1,960	100	16
2,5	31746	2,500	2,460	112	18
3	31747	3,000	2,960	126	20
4	31748	4,000	3,952	140	25
5	31749	5,000	4,952	160	28
6	31750	6,000	5,952	180	32
7	31751	7,000	6,942	190	34
8	31752	8,000	7,942	200	36
9	31753	9,000	8,942	204	38
10	31754	10,000	9,942	224	40
12	31755	12,000	11,890	243	47
14	32613	14,000	13,960	280	56
17	32614	17,000	16,952	320	63
19	32615	19,000	18,952	352	68

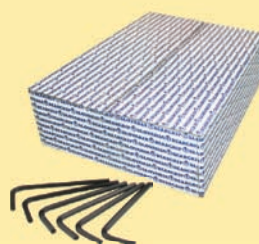

MM = 2311XL INBUSOVÉ KLÚČE S GULIČKOU EXTRA DLHÉ,
POVRCHOVÁ ÚPRAVA CHRÓMOVANIE
ISO 2936 (DIN 911), 54°-56°HRc

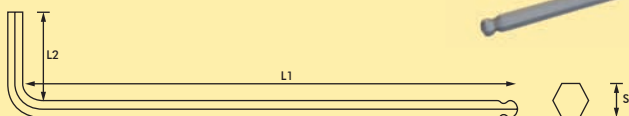

2311 XL mm	obj. kód balenie PE sáčok	S max mm	S min mm	L1 mm	L2 mm
1,5	34530	1,500	1,475	90	14
2	34531	2,000	1,960	100	16
2,5	34532	2,500	2,460	112	18
3	34533	3,000	2,960	126	20
4	34534	4,000	3,952	140	25
5	34535	5,000	4,952	160	28
6	34536	6,000	5,952	180	32
8	34537	8,000	7,942	200	36
9	34538	9,000	8,942	204	38
10	34539	10,000	9,942	224	40



Beargrip s.r.o.
Kollárova 88
03601 Martin
Slovakia
T: +421 434 003 605
F: +421 434 003 604
E: mail@beargrip.com
I: www.beargrip.com

MM INCH INBUSOVÉ KLÚČE S GULIČKOU DLHÉ, POVRCHOVÁ ÚPRAVA ČIERNENIE ISO 2936 (DIN 911), 54°-56°HRc, BS 2470, 54°-56°HRc

SADA V SKLÁPACOM DRŽIAKU NA BLISTRI

○ = 2346L

obj. kód	○	veľkosti	ks
30443	mm	1,5 - 2 - 2,5 - 3 - 4 - 5 - 6 - 8 - 10	9
34605	mm	1,5 - 2 - 2,5 - 3 - 4 - 5 - 6 - 8	10
		10 - 12	

○ = 1346

obj. kód	○	veľkosti	ks
30441	inch	1/16 - 5/64 - 3/32 - 1/8 - 5/32	9
		3/16 - 1/4 - 5/16 - 3/8"	

Pozri str. 11 pre veľkosti L1 a L2.



MM INBUSOVÉ KLÚČE S GULIČKOU EXTRA DLHÉ, POVRCHOVÁ ÚPRAVA ČIERNENIE ISO 2936 (DIN 911), 54°-56°HRc

SADA V SKLÁPACOM DRŽIAKU NA BLISTRI

○ = 2346XL

obj. kód	○	veľkosti	ks
30473	mm	1,5 - 2 - 2,5 - 3 - 4 - 5 - 6 - 8 - 10	9
34606	mm	1,5 - 2 - 2,5 - 3 - 4 - 5 - 6 - 8	10
		10 - 12	

Pozri str. 12 pre veľkosti L1 a L2.



INBUSOVÉ KLÚČE

**MM INBUSOVÉ KLÚČE S GULIČKOU EXTRA DLHÉ,
POVRCHOVÁ ÚPRAVA CHRÓMOVANIE
ISO 2936 (DIN 911), 54°-56°HRc**

SADA V SKLÁPACOM DRŽIAKU NA BLISTRI

○ = 2346XL

obj. kód	○	velkosti	ks
34170	mm	1,5 - 2 - 2,5 - 3 - 4 - 5 - 6 - 8 - 10	9

Pozri str. 12 pre veľkosti L1 a L2.

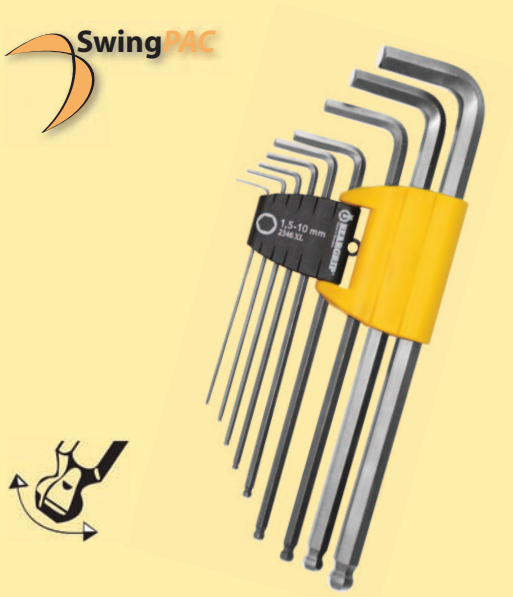

Možnosť ďalších farebných prevedí na požiadanie



Beargrip s.r.o.
Kollárova 88
03601 Martin
Slovakia
T: +421 434 003 605
F: +421 434 003 604
E: mail@beargrip.com
I: www.beargrip.com

**☰ = 2600 TORX KLÍČE, POVRCHOVÁ ÚPRAVA ČIERNENIE
54°-56°HRc**

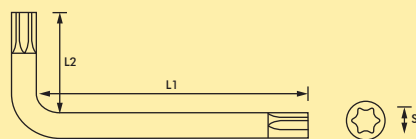

Tx	obj. kód balenie PE sáčok (S)	obj. kód balenie blister	L1 mm	L2 mm
6	30862	-	48	16
7	30863	-	48	16
8	30864	-	48	16
9	30865	-	48	16
10	30866	-	51	17
15	30867	-	54	18
20	30868	-	57	19
25	30869	-	60	20
27	30870	-	63	22
30	30871	-	70	24
40	30872	-	76	26
45	30873	-	83	29
50	30874	-	95	32
55	30875	-	108	35
60	30876	-	121	38



**☰ = 2600R TORX KLÍČE VŔTANÉ, POVRCHOVÁ ÚPRAVA ČIERNENIE
54°-56°HRc**

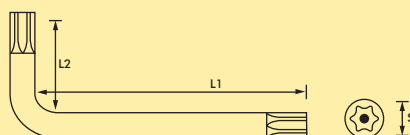

Tx.R	obj. kód balenie PE sáčok (S)	obj. kód balenie blister	L1 mm	L2 mm
6	31263	-	48	16
7	30877	-	48	16
8	30878	-	48	16
9	30879	-	48	16
10	30880	-	51	17
15	30881	-	54	18
20	30882	-	57	19
25	30883	-	60	20
27	30884	-	63	22
30	30885	-	70	24
40	30886	-	76	26
45	30887	-	83	29
50	30888	-	95	32
55	30889	-	108	35



INBUSOVÉ KLÍČE

TORX KLÍČE, POVRCHOVÁ ÚPRAVA ČIERNENIE 54°-56°HRc

SADA V SKLÁPACOM DRŽIAKU NA BLISTRI

 = 2646

obj. kód	velkosti	ks
30506	Tx. 8 - 9 - 10 - 15 - 20 - 25 - 27	9
	30 - 40	

 **SwingPAC**

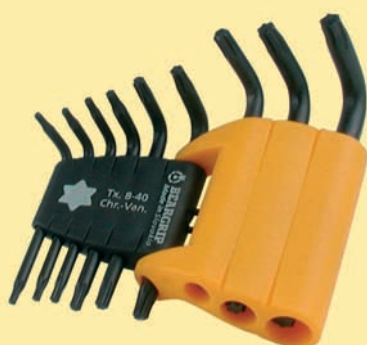

TORX KLÍČE VŔTANÉ, POVRCHOVÁ ÚPRAVA ČIERNENIE 54°-56°HRc

SADA V SKLÁPACOM DRŽIAKU NA BLISTRI

 = 2646R

obj. kód	velkosti	ks
30477	Tx.R 8 - 9 - 10 - 15 - 20 - 25 - 27	9
	30 - 40	

 **SwingPAC**

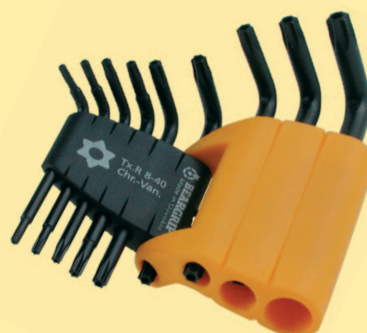

Beargrip s.r.o.
Kollárova 88
03601 Martin
Slovakia
T: +421 434 003 605
F: +421 434 003 604
E: mail@beargrip.com
I: www.beargrip.com

**TORX KLÚČE, TORX KLÚČE VRTANÉ,
POVRCHOVÁ ÚPRAVA ČIERNENIE
54°-56°HRc**

SADA NA KRÚŽKU NA BLISTRI

☼ = 2620

obj. kód	☼	veľkosti	ks
30640		Tx. 8 - 9 - 10 - 15 - 20 - 25 - 27 - 30 - 40	9

SADA NA KRÚŽKU NA BLISTRI

☼ = 2623R

obj. kód	☼	veľkosti	ks
1971		Tx.R 9 - 10 - 15 - 20 - 25 - 27 - 30 - 40	8

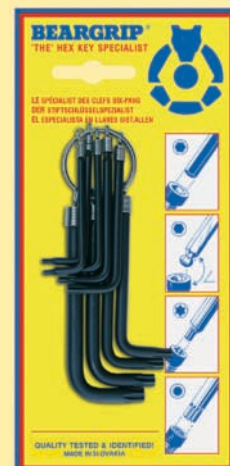

**DREVENÉ PREZENTAČNÉ KAZETY
TORX KLÚČOV, TORX KLÚČOV VRTANÝCH
MM**

☼ = 2660

séria	obj. kód balenie PE sáčok	☼	mm	ks
2600	30862	6	30	
2600	30863	7	30	
2600	30864	8	30	
2600	30865	9	30	
2600	30866	10	30	
2600	30867	15	30	
2600	30868	20	30	
2600	30869	25	30	
2600	30870	27	30	
2600	30871	30	20	
2600	30872	40	10	
2600	30873	45	10	
2600	30874	50	10	

2660 31261 plná - 320ks
2660 32732 prázdna



MM

☼ = 2660R

séria	obj. kód balenie PE sáčok	☼	mm	ks
2600R	31263	6	30	
2600R	30877	7	30	
2600R	30878	8	30	
2600R	30879	9	30	
2600R	30880	10	30	
2600R	30881	15	30	
2600R	30882	20	30	
2600R	30883	25	30	
2600R	30884	27	30	
2600R	30885	30	20	
2600R	30886	40	10	
2600R	30887	45	10	
2600R	30888	50	10	

2660R 31262 plná - 320ks
2660R 32732 prázdna



TORX KLÚČE

PREČO BEARGRIP KLÚČE?

Beargrip vyrába a dodáva kľúče takmer do celého sveta od roku 1960. Na Slovensko sa dostali v roku 2013 spolu so strojmi a technológiou na ich výrobu. Všetky kľúče Beargrip sú vyrábané 100% na Slovensku od počiatočného delenia materiálu, cez opracovanie vstupných hrán, alebo guľôčky. Naklápacia guľôčka prevyšuje štandard, bežne vyrábané kľúče majú uhol 25°, zatiaľ čo kľúče Beargrip až 30°. Použitý materiál je 59 - 61 Cr-V. Kalenie na 54 - 56 HRC zabezpečuje kaliareň RÚBIG v Prievidzi. Každá vyrobená séria je testovaná na tvrdosť a skrut, aby zodpovedala normám DIN 911. Následne sú povrchovo upravené čiernením a chránené konzervačným olejom. Kvalitný kľúč vzniká len použitím kvalitného materiálu a dodržiavaním technológie. V praxi ho poznáte tak, že pri doťahovaní skrutky nedôjde k okamžitému prasknutiu kľúča, čo má za následok náraz ruky do kovovej časti, často aj porezanie na ostrej hrane, ktorá vzniká v mieste prekalenia. U kľúča Beargrip k takémuto prasknutiu nedôjde. K deformácii dochádza postupne - skrutkom v krátkej časti, čo je viditeľné a citelné. Mechanik pri deformácii môže prestať doťahovať - povoľovať skrutku bez ublíženia. Samozrejme po prekročení tejto hranice dôjde aj u nášho kľúča Beargrip k vyčerpaniu plasticity materiálu a následnému zlomeniu. Zlomenú časť z hlavičky ľahko vyklepnete, lebo vďaka dodržaným presnostiam a toleranciam nedochádza k zaseknutiu, alebo poškodeniu profilu hlavičky skrutky.

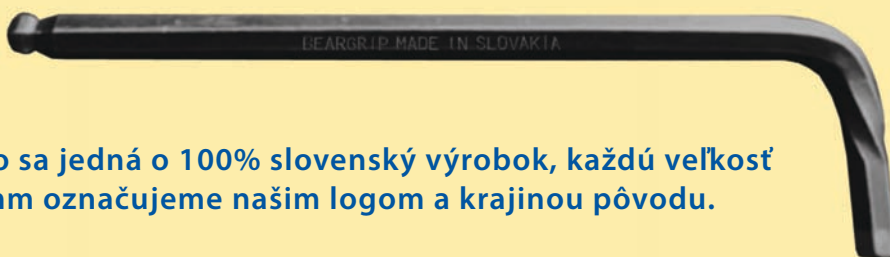

Nakoľko sa jedná o 100% slovenský výrobok, každú veľkosť nad 3 mm označujeme našim logom a krajinou pôvodu.

Kľúče dodávame jednotlivo, v kazetách, v plastových klipoch, v pvc púzdрах ako skrutkovače.



Beargrip s.r.o.
Kollárova 88
03601 Martin
Slovakia
T: +421 434 003 605
F: +421 434 003 604
E: mail@beargrip.com
I: www.beargrip.com

☼ = 2800 TORX KLÍČE DLHÉ, POVRCHOVÁ ÚPRAVA ČIERNENIE 54°-56°HRc

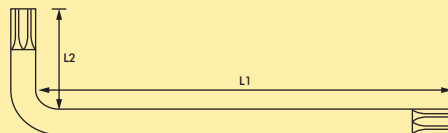

Tx (S)	obj. kód balenie PE sáčok	obj. kód balenie blister	L1 mm	L2 mm
8	30890	-	78	16
9	30891	-	82	16
10	30892	-	86	17
15	30893	-	90	18
20	30894	-	95	19
25	30895	-	100	20
27	30896	-	105	22
30	30897	-	114	24
40	30898	-	124	26



SADA V SKLÁPACOM DRŽIAKU NA BLISTRI

obj. kód	☼	velkosti	ks
30479		Tx. 8 - 9 - 10 - 15 - 20 - 25 - 27 - 30 - 40	9

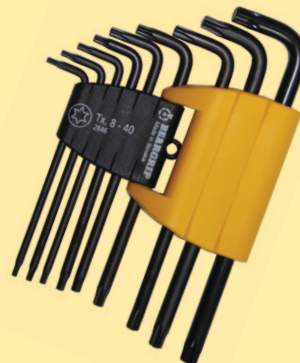

TORX KLÍČE

**☼ = 2800XL TORX KLÍČE EXTRA DLHÉ,
POVRCHOVÁ ÚPRAVA ČIERNENIE
54°-56°HRc**

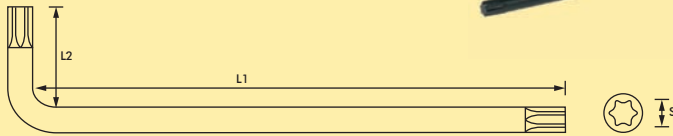

Tx (S)	obj. kód balenie PE sáčok	L1 mm	L2 mm
8	34511	84	16
9	34512	85	16
10	34513	86	17
15	34514	101	18
20	34515	110	19
25	34517	125	21
27	34518	141	24
30	34519	162	27
40	34520	180	32



SADA V SKLÁPACOM DRŽIAKU NA BLISTRI

☼ = 2846XL

obj. kód	☼	ks
33936	Tx. 8 - 9 - 10 - 15 - 20 - 25 - 27 - 30 - 40	9

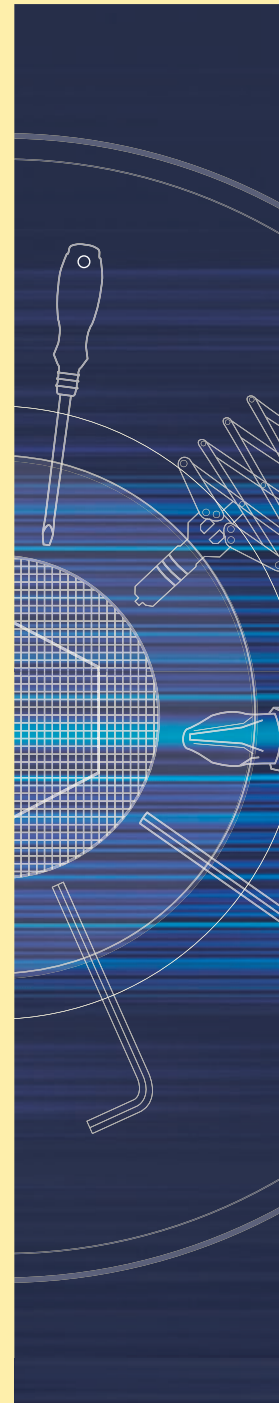
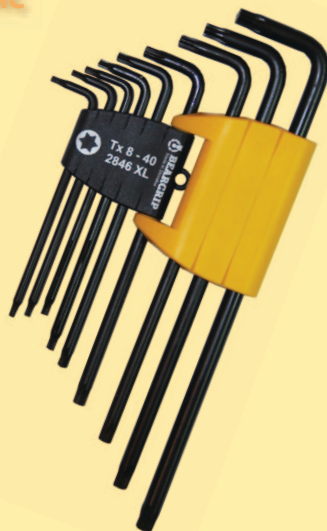

Beargrip s.r.o.
Kollárova 88
03601 Martin
Slovakia
T: +421 434 003 605
F: +421 434 003 604
E: mail@beargrip.com
I: www.beargrip.com

☼ = 2800BE TORX KLÚČE S GULIČKOU DLHÉ, POVRCHOVÁ ÚPRAVA ČIERNENIE 54°-56°HRc

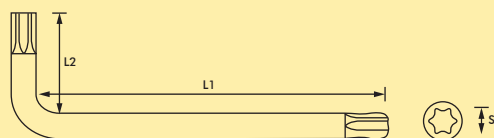

Tx	obj. kód balenie PE sáčok	L1 mm	L2 mm
8	34521	78	16
9	34522	82	16
10	34523	86	17
15	34524	90	18
20	34525	95	19
25	34526	100	20
27	34527	105	22
30	34528	114	24
40	34529	124	26



SADA V SKLÁPACOM DRŽIAKU NA BLISTRI

obj. kód	☼	velkosti	ks
33374		Tx. 8 - 9 - 10 - 15 - 20 - 25 - 27 - 30 - 40	9

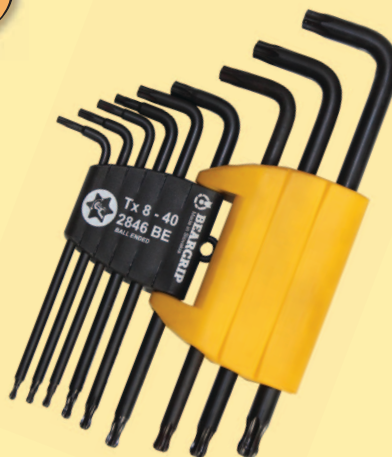

TORX KLÚČE

MM INBUSOVÉ KLÚČE, KLÚČE S GULIČKOU, TORX KLÚČE,
POVRCHOVÁ ÚPRAVA ČIERNENIE
INCH ISO 2936 (DIN 911), 54°-56°HRC, BS 2470, 54°-56°HRC

SADA KLÚČOV V PLASTOVOM DRŽIAKU SOFT GRIP, BALENÁ NA KARTE



6-hranné klúče, metrické

○ = 2281	obj. kód	○	veľkosti	ks
	31581	mm	1,5 - 2 - 2,5 - 3 - 4 - 5 - 6 - 8	8
○ = 2282	30300	mm	2,5 - 3 - 4 - 5 - 6 - 8 - 10	7

6-hranné klúče, palcové

○ = 1281	obj. kód	○	veľkosti	ks
	31588	inch	1/16 - 5/64 - 3/32 - 1/8 - 5/32 - 3/16	8
			1/4 - 5/16"	
○ = 1282	31589	inch	3/32 - 1/8 - 5/32 - 3/16 - 1/4 - 5/16 - 3/8"	7

Inbus klúče s guľičkou, metrické

○ = 2382	obj. kód	○	veľkosti	ks
	31742	mm	2,5 - 3 - 4 - 5 - 6 - 8 - 10	7



Inbus klúče s guľičkou, palcové

○ = 1382	obj. kód	○	veľkosti	ks
	31743	inch	3/32 - 1/8 - 5/32 - 3/16 - 1/4 - 5/16 - 3/8"	7

Torx klúče

☆ = 2682	obj. kód	☆	veľkosti	ks
	29999		Tx. 9 - 10 - 15 - 20 - 25 - 27 - 30 - 40	8

☆ = 2682R	obj. kód	☆	veľkosti	ks
	31553		Tx.R 9 - 10 - 15 - 20 - 25 - 27 - 30 - 40	8



Beargrip s.r.o.
Kollárova 88
03601 Martin
Slovakia
T: +421 434 003 605
F: +421 434 003 604
E: mail@beargrip.com
I: www.beargrip.com



OCENENÝ AWARD FOR GOOD NAGRODA DLA PREMIJA ZA DIJA JÓ
DIZAJNOU INDUSTRIAL DOBRAPRZEMYSŁOWY HOROSHEE
KOMOROU DESIGN PROJEKT PROMYSLIENNE IPARI
V HANNOVERI HANNOVER HANNOVER DIZAJN HANNOVER TERVEZÉS
HANNOVER HANNOVER HANNOVER HANNOVER

SoftGrip vrecková sada klúčov

Vývoj vreckovej sady klúčov



r. 1970

r. 2015

Charakteristické prvky produktu:

- jedinečný a ergonomický dizajn
- dokonalé a presné uchopenie
- farebné odlišenie modelov
- tlačidlo pre vysunutie
- otvor pre zavesenie

Dokonalá kombinácia materiálov !



MADE IN SLOVAKIA

Táto vrecková sada klúčov sa vyznačuje veľmi komfortným otváraním (obr. 1) z každej strany (veľké aj malé klúče). Pri vyberaní klúčov nie je potrebné podberať klúče nechťom. Klúče jednoducho vytiahneme pomocou stlačenia tlačidla "PUSH" (obr. 2).



Pevné uchopenie vďaka protišmykovej gume pripomínajúcej gumu na podrážkách topánok (obr. 3). Zapustené spojovacie skrutky nebránia pevnému uchopeniu, taktiež nevzniká riziko pošmyknutia (odtláčanie) prsta na vystúpenej hlave kovovej spojovacej skrutky (obr. 4).

Farebné odlišenie jednotlivých modelov podľa typu použitých klúčov (MM - AF - TORX).



Farebná plastová časť má vo svojom vnútri mikro vzduchové bubliny, ktoré zlepšujú jej pevnosť - štruktúru plastu. Materiál klúčov je vysoko kvalitná legovaná ocel' (59-61Cr-V). Klúče sú povrchovo upravené čiernením.

Jednotlivé klúče sú vymedzené vlnitými pružnými podložkami (obr. 5), ktoré zabezpečia umiestnenie v správnej polohe vždy len jedného klúča, zatiaľ čo ostatné zostávajú zasunuté, pričom nedochádza k samovoľnému otvoreniu.

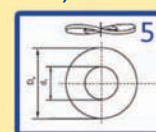

Každý jeden model je individuálne testovaný pred expedíciou. Pri použití nehrozí žiadna strata klúčov, pretože sú jednotlivé klúče nedemontovateľné.



INBUSOVÉ KLÚČE
TORX KLÚČE

Spojovací materiál s tvrdosťou 10.9, vďaka pevnému spojeniu nehrozí prasknutie alebo povolenie aj pri veľkej námahe.

Praktický otvor pre zavesenie.

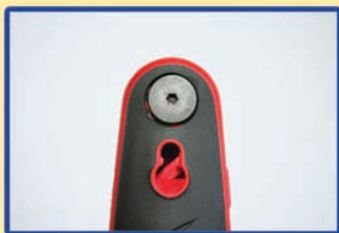

Na pranie zákazníka možnosť dodania jednotlivých modelov s vlastnou potlačou a taktiež so závesnou kartičkou obsahujúcou dôležité informácie.



MM – SOFTGRIP FUTURO vrecková sada kľúčov, ISO 2936 (DIN911), 54°-56°HRC
INCH - SOFTGRIP FUTURO vrecková sada kľúčov, BS 2470, 54°-56°HRC
Prevedenie ako inbus, torx, inbus s guľôčkou, povrchová úprava čierne.



Flexibilný systémový panel zobrazenia Beargrip produktov

Vzhľadom na široké portfólium produktov spoločnosti Beargrip kombinuje tento flexibilný systém zobrazenia produktov mnohé prednosti a v neposlednom rade aj ekonomickú úsporu. Výhodou tohto systému zobrazenia je jeho ľahká prenosnosť a možnosť zvolenia si požadovanej dĺžky tohto zobrazovacieho panelu Beargrip (v závislosti od rozsahu produktov). Rozmery zobrazovacieho panela sú 4 cm na výšku a 10 cm na šírku (1.5"x4"). Určené pre montáž na akýkoľvek typ steny. Možnosť taktiež akéhokoľvek iného usporiadania zobrazenia.

34634 flexibilný panel zobrazenia produktov



Beargrip s.r.o.
Kollárova 88
03601 Martin
Slovakia
T: +421 434 003 605
F: +421 434 003 604
E: mail@beargrip.com
I: www.beargrip.com

MM INBUSOVÉ KLÚČE, KLÚČE S GULIČKOU, TORX KLÚČE,
INCH POVRCHOVÁ ÚPRAVA ČIERNENIE
 ISO 2936 (DIN 911), 54°-56°HRc, BS 2470, 54°-56°HRc

SADA KLÚČOV V PLASTOVO-KOVOVOM DRŽIAKU FUTURO,
 BALENÁ NA KARTE

6-hranné klúče, metrické



séria	obj. kód	Ø	velkosti	ks
2290	31583	mm	1,5 - 2 - 2,5 - 3 - 4 - 5 - 6	7
2290	33315	mm	1,5 - 2 - 2,5 - 3 - 4 - 5 - 6	7
2291	31584	mm	2,5 - 3 - 4 - 5 - 6 - 8	6
2292	30297	mm	2,5 - 3 - 4 - 5 - 6 - 8 - 10	7
2292	33317	mm	2,5 - 3 - 4 - 5 - 6 - 8 - 10	7



6-hranné klúče, palcové



séria	obj. kód	Ø	velkosti	ks
1290AF	31591	inch	1/16 - 5/64 - 3/32 - 1/8 - 5/32 - 3/16 - 7/32"	7
1291AF	31592	inch	3/32 - 1/8 - 5/32 - 3/16 - 1/4 - 5/16"	6
1292AF	30478	inch	3/32 - 1/8 - 5/32 - 3/16 - 1/4 - 5/16 - 3/8"	7



Inbus klúče s guľičkou, metrické



séria	obj. kód	Ø	velkosti	ks
2392	30529	mm	2,5 - 3 - 4 - 5 - 6 - 8 - 10	7



Inbus klúče s guľičkou, palcové



séria	obj. kód	Ø	velkosti	ks
1392	30532	inch	3/32 - 1/8 - 5/32 - 3/16 - 1/4 - 5/16 - 3/8"	7



Torx klúče



séria	obj. kód	Ø	velkosti	ks
2692	30530		Tx. 9 - 10 - 15 - 20 - 25 - 27 - 30 - 40	8



séria	obj. kód	Ø	velkosti	ks
2690R	31554		Tx.R 6 - 7 - 8 - 9 - 10 - 15 - 20 - 25	8
2692R	30531		Tx.R 9 - 10 - 15 - 20 - 25 - 27 - 30 - 40	8



INBUSOVÉ KLÚČE
 TORX KLÚČE

MM = 2300
INCH = 1300



SKRUTKOVÁČE INBUS, POVRCHOVÁ ÚPRAVA ČIERNENIE
ISO 2936 (DIN 911), 54°-56°HRc, BS 2470, 54°-56°HRc
JEDNOKOMPONENTNÁ ZELENÁ RUKOVÄŤ

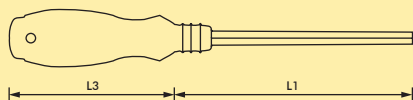

(S)	obj. kód	L1	L3
mm		mm	mm
1,5	34463	75	75
2	31593	75	75
2,5	31013	75	75
3	31594	120	90
4	31595	120	90
5	31596	125	100
6	31597	180	100
8	31598	185	110
10	31599	185	110

(S)	obj. kód	L1	L3
inch		inch	inch
5/64	31601	3	3
3/32	31602	3	3
1/8	31603	4	3,5
5/32	31604	4	3,5
3/16	31605	5	4
7/32	31606	5	4
1/4	31607	7	4
5/16	31608	7	4 3/8
3/8	31609	7	4 3/8



SADA V TEXTILNEJ TAŠKE

○ = 2305

obj. kód	○	veľkosti	ks
31600	mm	2 - 2,5 - 3 - 4 - 5 - 6 - 8 - 10	8

○ = 1305

obj. kód	○	veľkosti	ks
31610	inch	5/64 - 3/32 - 1/8 - 5/32 - 3/16 7/32 - 1/4 - 5/16 - 3/8"	9



SADA V KRABICI

○ = 2305

obj. kód	○	veľkosti	ks
31911	mm	2 - 2,5 - 3 - 4 - 5 - 6 - 8 - 10	8

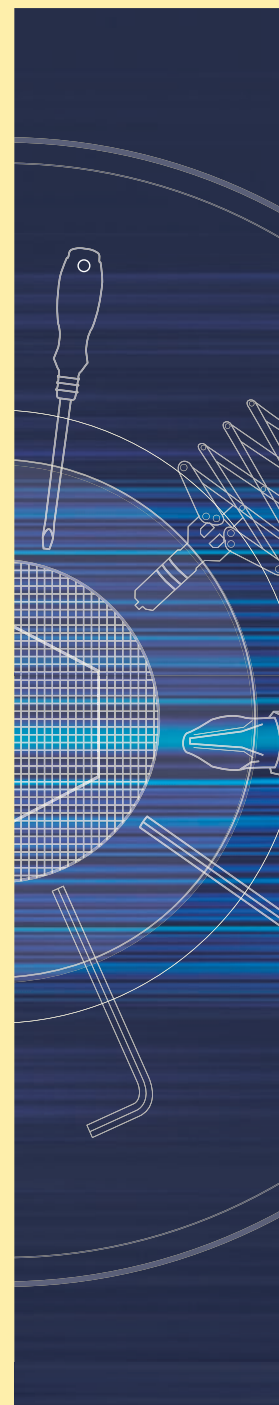

Beargrip s.r.o.
Kollárova 88
03601 Martin
Slovakia
T: +421 434 003 605
F: +421 434 003 604
E: mail@beargrip.com
I: www.beargrip.com

MM = 2310
INCH = 1310



SKRUTKOVAČE INBUS S GULIČKOU,
POVRCHOVÁ ÚPRAVA ČIERNENIE
ISO 2936 (DIN 911), 54°-56°HRc, BS 2470, 54°-56°HRc
JEDNOKOMPONENTNÁ ZELENÁ RUKOVÄŤ

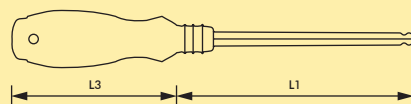

(S)	obj. kód	L1	L3
mm		mm	mm
2	31689	75	75
2,5	31690	75	75
3	31691	120	90
4	31014	120	90
5	31692	125	100
6	31693	180	100
8	31694	185	110
10	31695	185	110



(S)	obj. kód	L1	L3
inch		inch	inch
5/64	31707	3	3
3/32	31708	3	3
1/8	31709	4	3,5
5/32	31710	4	3,5
3/16	31711	5	4
7/32	31712	5	4
1/4	31713	7	4
5/16	31714	7	4 3/8
3/8	31715	7	4 3/8

SADA V TEXTILNEJ TAŠKE

= 2315	obj. kód	veľkosti	ks
	31696	mm 2 - 2,5 - 3 - 4 - 5 - 6 - 8 - 10	8

= 1315	obj. kód	veľkosti	ks
	31716	inch 5/64 - 3/32 - 1/8 - 5/32 - 3/16 7/32 - 1/4 - 5/16 - 3/8"	9



SADA V KRABICI

= 2315	obj. kód	veľkosti	ks
	31912	mm 2 - 2,5 - 3 - 4 - 5 - 6 - 8 - 10	8



SKRUTKOVAČE INBUS

MM = 2330
INCH = 1330

INBUSOVÉ KLÚČE S T-RUKOVÄŤOU, POVRCHOVÁ ÚPRAVA ČIERNENIE
ISO 2936 (DIN 911), 54°-56°HRc, BS 2470, 54°-56°HRc
JEDNOKOMPONENTNÁ, JEDNOSMERNÁ ZELENÁ RUKOVÄŤ

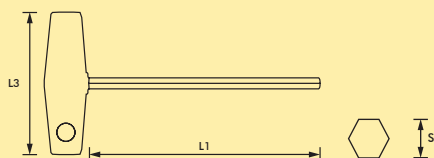

(S)	obj. kód	L1	L3
mm		mm	mm
2	31632	100	90
2,5	31633	100	90
3	31634	100	90
4	31635	100	90
5	31636	100	90
6	31637	100	90
8	31638	100	90
10	31639	100	110

(S)	obj. kód	L1	L3
inch		inch	inch
3/32	31656	6	3,5
7/64	31657	6	3,5
1/8	31658	6	3,5
9/64	31659	6	3,5
5/32	31660	6	3,5
3/16	31661	6	3,5
7/32	31662	6	3,5
1/4	31663	6	3,5
5/16	31664	6	3,5
3/8	31665	6	4 1/4

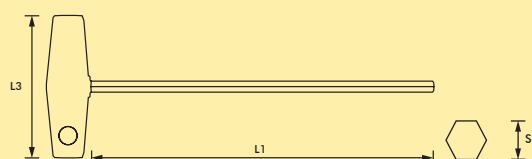

(S)	obj. kód	L1	L3
mm		mm	mm
2	31641	150	90
2,5	31642	150	90
3	31643	150	90
4	31644	150	90
5	31645	150	90
6	31646	150	90
8	31647	150	90
10	31648	150	110

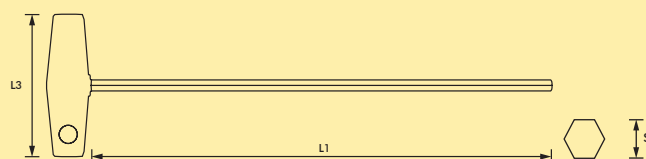

(S)	obj. kód	L1	L3
mm		mm	mm
4	31650	200	90
5	31651	200	90
6	31652	200	90
8	31653	200	90
10	31654	200	110

SADY V PLECHOVOM STOJANE V KARTÓNOVEJ KRABICI

○ = 2335

obj. kód	L	○	velkosti	ks
31640	100	mm	2 - 2,5 - 3 - 4 - 5 - 6 - 8 - 10	8
31649	150	mm	2 - 2,5 - 3 - 4 - 5 - 6 - 8 - 10	8
31655	200	mm	2 - 2,5 - 3 (150 mm) 4 - 5 - 6 - 8 - 10 (200 mm)	8

○ = 1335

obj. kód	L	○	velkosti	ks
31666	6	inch	3/32 - 1/8 - 5/32 - 3/16 - 7/32 - 1/4 5/16 - 3/8"	8



Beargrip s.r.o.
Kollárova 88
03601 Martin
Slovakia
T: +421 434 003 605
F: +421 434 003 604
E: mail@beargrip.com
I: www.beargrip.com

MM = 2340
INCH = 1340



INBUSOVÉ KLÚČE S T-RUKOVÄŤOU,
POVRCHOVÁ ÚPRAVA ČIERNENIE
ISO 2936 (DIN 911), 54°-56°HRc, BS 2470, 54°-56°HRc
JEDNOKOMPONENTNÁ, DVOJSMERNÁ ZELENÁ RUKOVÄŤ

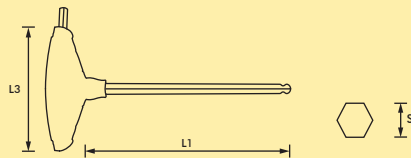

(S)	obj. kód	L1	L3
mm		mm	mm
2	31611	150	75
2,5	31612	150	75
3	31613	150	75
4	31614	150	90
5	31615	150	90
6	31616	150	90
8	31617	150	110
10	31618	150	110

(S)	obj. kód	L1	L3
inch		inch	inch
5/64	31620	6	3
3/32	31621	6	3
7/64	31622	6	3
1/8	31623	6	3
9/64	31624	6	3
5/32	31625	6	3,5
3/16	31626	6	3,5
7/32	31627	6	3,5
1/4	31628	6	3,5
5/16	31629	6	4 3/8
3/8	31630	6	4 3/8

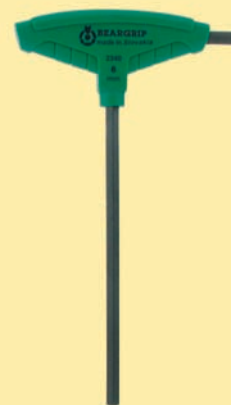

SADY V PLECHOVOM STOJANE V KARTÓNOVEJ KRABICI

⊙ = 2345

obj. kód	L	⊙	velkosti	ks
31619	150	mm	2 - 2,5 - 3 - 4 - 5 - 6 - 8 - 10	8

⊙ = 1345

obj. kód	L	⊙	velkosti	ks
31631	6	inch	3/32 - 1/8 - 5/32 - 3/16 - 7/32 1/4 - 5/16 - 3/8"	8



INBUSOVÉ KLÚČE
S T-RUKOVÄŤOU

MM = 2341

**INBUSOVÉ KLÚČE S T-RUKOVÄŤOU A GULIČKOU,
POVRCHOVÁ ÚPRAVA ČIERNENIE
ISO 2936 (DIN 911), 54°-56°HRc
JEDNOKOMPONENTNÁ, DVOJSMERNÁ ZELENÁ RUKOVÄŤ**

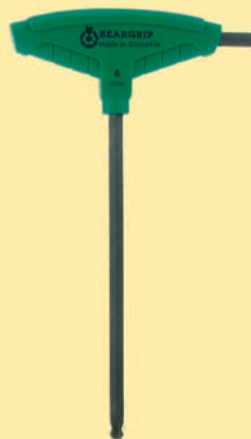
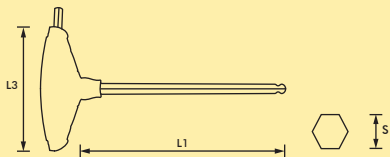

(S) mm	obj. kód	L1 mm	L3 mm
2	31697	150	75
2,5	31698	150	75
3	31699	150	75
4	31700	150	90
5	31701	150	90
6	31702	150	90
8	31703	150	110
10	31704	150	110



SADA V PLECHOVOM STOJANE V KARTÓNOVEJ KRABICI

○ = 2350

obj. kód	L	○	veľkosti	ks
31706	150	mm	2 - 2,5 - 3 - 4 - 5 - 6 - 8 - 10	8



Možnosť ďalších farebných prevedení na požiadanie

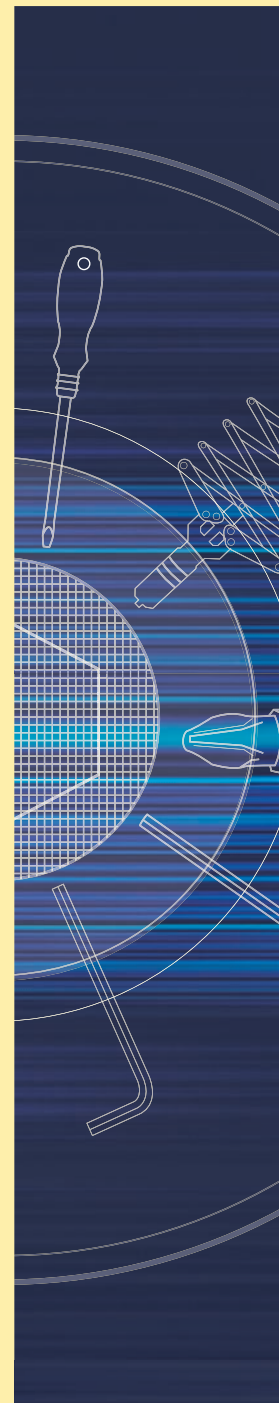

Beargrip s.r.o.
Kollárova 88
03601 Martin
Slovakia
T: +421 434 003 605
F: +421 434 003 604
E: mail@beargrip.com
I: www.beargrip.com

☼ = 2605

**TORX KLÚČE S T-RUKOVÄŤOU, POVRCHOVÁ ÚPRAVA ČIERNENIE
54°-56°HRc**

JEDNOKOMPONENTNÁ, JEDNOSMERNÁ ZELENÁ RUKOVÄŤ

(S) tx.	obj. kód	L1 mm	L3 mm
8	31503	150	90
9	31504	150	90
10	31505	150	90
15	31506	150	90
20	31507	150	90
25	31508	150	90
27	31509	150	90
30	31510	150	90
40	31511	150	90
45	31512	150	110
50	31513	150	110
55	31514	150	110

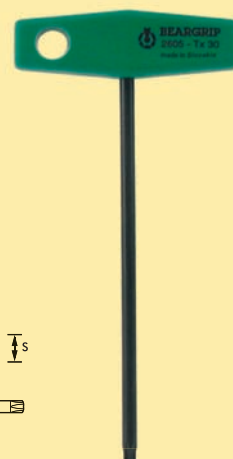
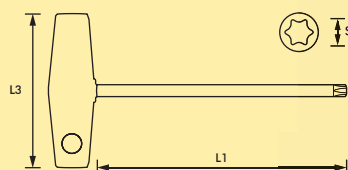

SADA V PLECHOVOM STOJANE
V KARTÓNOVEJ KRABICI

☼ = 2635

obj. kód	☼	veľkosti	ks
31515		Tx. 9 - 10 - 15 - 20 - 25 - 27 - 30 - 40	8



☼ = 2640

**TORX KLÚČE S T-RUKOVÄŤOU, POVRCHOVÁ ÚPRAVA ČIERNENÍM
54°-56°HRc**

JEDNOKOMPONENTNÁ, DVOJSMERNÁ ZELENÁ RUKOVÄŤ

(S) tx.	obj. kód	L1 mm	L3 mm
8	31516	150	75
9	31517	150	75
10	31518	150	75
15	31519	150	90
20	31520	150	90
25	31521	150	90
27	31522	150	90
30	31523	150	90
40	31524	150	90
45	31525	150	110
50	31526	150	110
55	31527	150	110

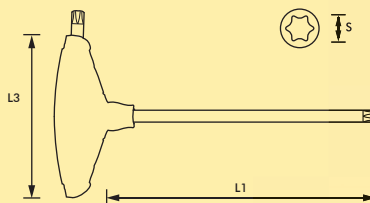

SADA V PLECHOVOM STOJANE
V KARTÓNOVEJ KRABICI

☼ = 2645

obj. kód	☼	veľkosti	ks
31528		Tx. 9 - 10 - 15 - 20 - 25 - 27 - 30 - 40	8



TORX KLÚČE

☼ = 2610
TORX SKRUTKOVAČE,
POVRCHOVÁ ÚPRAVA ČIERNENIE
54°-56°HRc
JEDNOKOMPONENTNÁ ZELENÁ RUKOVÄŤ

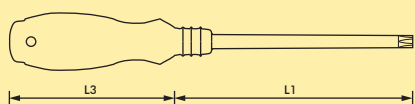

(S)	obj. kód	L1	L3	☼	s
tx.		mm	mm		
6	34607	165	75		
7	34608	165	75		
8	31529	165	75		
9	31530	165	75		
10	32005	165	75		
15	31531	165	90		
20	31532	165	90		
25	31533	170	90		
27	31534	170	90		
30	31535	170	100		
40	31536	170	100		
45	31537	170	110		
50	31538	170	110		
55	31539	170	110		

☼ = 2610R
TORX SKRUTKOVAČE VŔTANÉ,
POVRCHOVÁ ÚPRAVA ČIERNENIE
54°-56°HRc
JEDNOKOMPONENTNÁ ZELENÁ RUKOVÄŤ

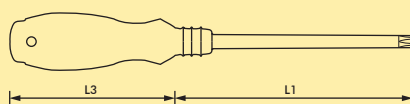

(S)	obj. kód	L1	L3	☼	s
tx.		mm	mm		
6	31541	165	75		
7	31542	165	75		
8	31543	165	75		
9	31544	165	75		
10	31545	165	75		
15	31546	170	90		
20	31547	170	90		
25	31548	170	90		
27	31549	170	90		
30	31550	170	100		
40	31551	170	100		



SADA V TEXTILNEJ TAŠKE

☼ = 2615

obj. kód	☼	velkosti	ks
31540		Tx. 8 - 9 - 10 - 15 - 20 - 25 - 27 - 30 - 40	9



SADY V KRABICI

☼ = 2615

obj. kód	☼	velkosti	ks
31909		Tx. 8 - 9 - 10 - 15 - 20 - 25 - 27 - 30 - 40	9

☼ = 2615R

obj. kód	☼	velkosti	ks
31910		Tx.R 8 - 9 - 10 - 15 - 20 - 25 - 27 - 30 - 40	9

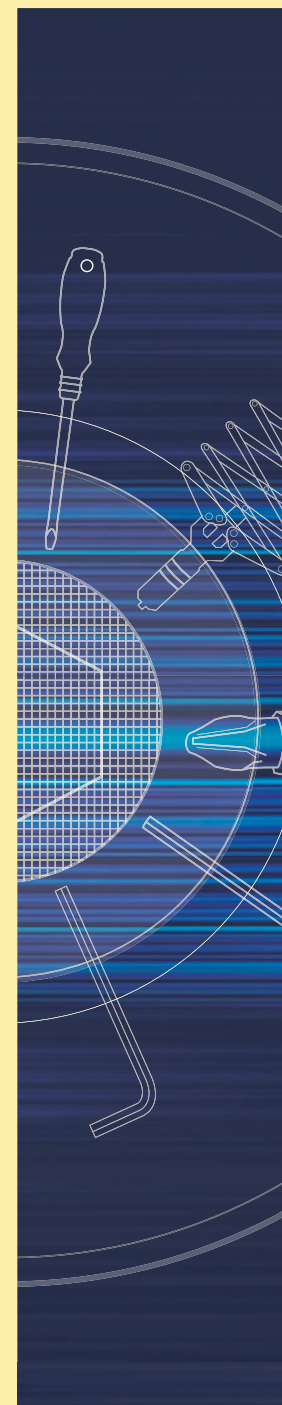

Beargrip s.r.o.
 Kollárova 88
 03601 Martin
 Slovakia
 T: +421 434 003 605
 F: +421 434 003 604
 E: mail@beargrip.com
 I: www.beargrip.com

☼ = 2670 TORX SKRUTKOVAČE, POVRCHOVÁ ÚPRAVA ČIERNENIE
54°-56°HRc
DOVKOMPONENTNÁ ZELENO-ČIERNÁ RUKOVÄŤ

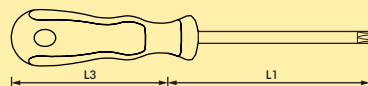

(S)	obj. kód	L1	L3
tx.		mm	mm
8	34501	165	75
9	34502	165	75
10	34503	165	75
15	34504	165	90
20	34505	165	90
25	34506	170	90
27	34507	170	90
30	34508	170	100
40	34509	170	100

SADA V KRABICI

☼ = 2675	obj. kód	☼	velkosti	ks
	34609		Tx. 10 - 15 - 20 - 25 - 30 - 40	6



Krabice BEARGRIP sú vybavené záväzným uškom a obsahujú informáciu o kvalite materiálov použitých na výrobu.

Na každej krabici BEARGRIP je pre jednoduchú orientáciu informácia:

- o veľkosti vložených produktov



- o komponentnosti rukoväti



- o počte kusov v krabici



- číslo série



TORX SKRUTKOVAČE

BEARGRIP skrutkovače najvyššej kvality, vyrobené z molybdénovo-kremíkovo-vanádiovej ocele s vysokou odolnosťou v skrute a napriek tomu s vysokou tvrdosťou. Pochromovaný, s leštenou čepelou a čiernou špičkou. Ergonomická rukoväť je vyrobená zo zaručene nerozbitného a proti nárazom odolného materiálu, umožňujúca maximálny krútiaci moment. Otvor na rúčke umožňuje zavesenie.

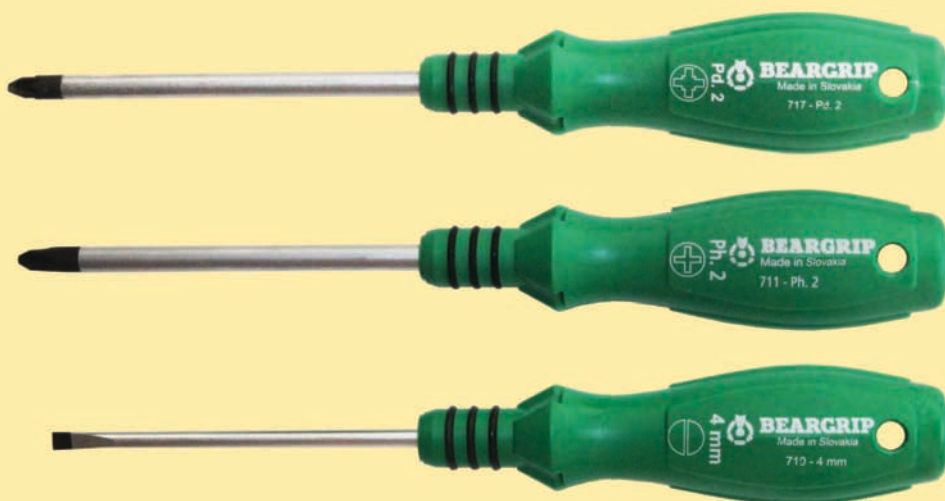

Možnosť ďalších farebných prevedí na požiadanie.

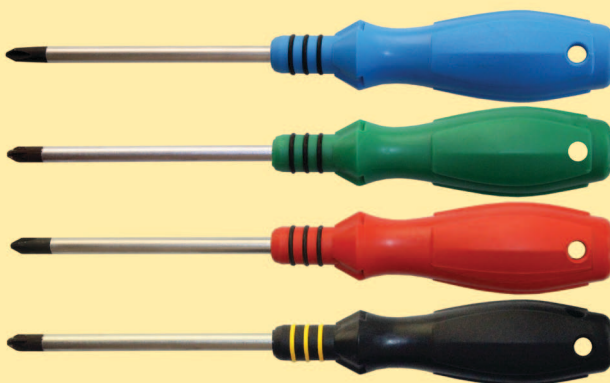



Možnosť dodania skrutkovačov na blistri.

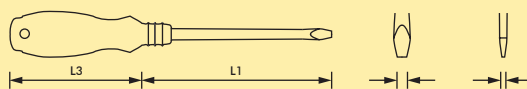

Beargrip s.r.o.
Kollárova 88
03601 Martin
Slovakia
T: +421 434 003 605
F: +421 434 003 604
E: mail@beargrip.com
I: www.beargrip.com

**⊖ = 710 SKRUTKOVAČE PLOCHÉ, ISO 2380 (DIN 5265)
JEDNOKOMPONENTNÁ ZELENÁ RUKOVÄŤ**



	obj. kód	L1		Ø	L3
mm		mm	mm	mm	mm
2,5	31834	75	0,4	2,5	75
3	31835	100	0,5	3	75
4	31836	100	0,8	4	90
5,5	31837	125	1,0	5,5	100
6,5	31838	150	1,2	6	100
8	31839	175	1,2	7	110
10	31840	200	1,6	8	110



**⊕ = 711 SKRUTKOVAČE KRÍŽOVÉ, ISO 2764 (DIN 5262)
JEDNOKOMPONENTNÁ ZELENÁ RUKOVÄŤ**

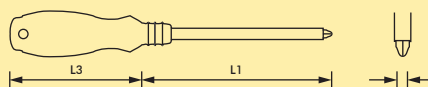

	obj. kód	L1		Ø	L3
		mm		mm	mm
Ph.0	31841	80		3,5	75
Ph.1	31842	100		5	90
Ph.2	31843	120		6	100
Ph.3	31844	150		8	110
Ph.4	31845	200		10	110



**⊕ = 717 SKRUTKOVAČE KRÍŽOVÉ, ISO 8764 (DIN 5262)
JEDNOKOMPONENTNÁ ZELENÁ RUKOVÄŤ**

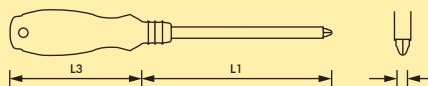

	obj. kód	L1		Ø	L3
		mm		mm	mm
Pd.1	31846	100		5	90
Pd.2	31847	120		6	100
Pd.3	31848	150		7	110





SKRUTKOVAČE

⊖ = 710 SKRUTKOVAČE PLOCHÉ, ISO 2380 (DIN 5265)

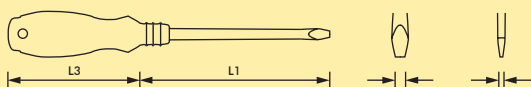
JEDNOKOMPONENTNÁ ČIERNA RUKOVÄŤ





	obj. kód	L1		Ø	L3
mm		mm	mm	mm	mm
2,5	32406	75	0,4	2,5	75
3	32407	100	0,5	3	75
4	32408	100	0,8	4	90
5,5	32409	125	1,0	5,5	100
6,5	32410	150	1,2	6,5	100
8	32411	175	1,2	8	105
10	32412	200	1,6	10	105

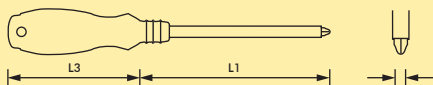

⊕ = 711 SKRUTKOVAČE KRÍŽOVÉ, ISO 2764 (DIN 5262)

JEDNOKOMPONENTNÁ ČIERNA RUKOVÄŤ



	obj. kód	L1		Ø	L3
		mm		mm	mm
Ph.0	32413	80		3,5	75
Ph.1	32414	100		5	90
Ph.2	32415	120		6	100
Ph.3	32416	150		8	105
Ph.4	32417	200		10	105



⊕ = 717 SKRUTKOVAČE KRÍŽOVÉ, ISO 8764 (DIN 5262)

JEDNOKOMPONENTNÁ ČIERNA RUKOVÄŤ

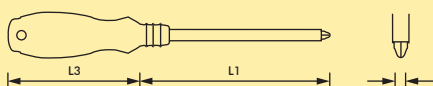



	obj. kód	L1		Ø	L3
		mm		mm	mm
Pd.1	32418	100		5	90
Pd.2	32419	120		6	95
Pd.3	32420	150		8	105



Beargrip s.r.o.
Kollárova 88
03601 Martin
Slovakia
T: +421 434 003 605
F: +421 434 003 604
E: mail@beargrip.com
I: www.beargrip.com

SADA NA BLISTRI



 = 725

obj. kód		veľkosti	ks
31166		4 - 5,5 - 6,5	
		Ph.1 - 2	5





SADY V KRABICI

 = 725

obj. kód		veľkosti	ks
31905		4 - 5,5 - 6,5	
		Ph.1 - 2	5





 = 725

obj. kód		veľkosti	ks
31903		4 - 5,5 - 6,5	
		Ph.1 - 2	5



SADA NA BLISTRI



 = 730

obj. kód		veľkosti	ks
31849		4 - 5,5 - 6,5	
		Pd.1 - 2	5





SADY V KRABICI

 = 730

obj. kód		veľkosti	ks
31906		4 - 5,5 - 6,5	
		Pd.1 - 2	5



 = 730

obj. kód		veľkosti	ks
31904		4 - 5,5 - 6,5	
		Pd.1 - 2	5



SKRUTKOVÁČE

SADY V KRABICI

LEN PLOCHÉ



obj. kód	mm	velkosti	ks
32075	☉	2,5 - 3 - 4 - 5,5 - 6,5 - 8	6



LEN KŘÍŽOVÉ



obj. kód		velkosti	ks
32076	⊕	Ph. 1 - 2 - 3	6
	⊕	Pd. 1 - 2 - 3	



KOMBINOVANÉ



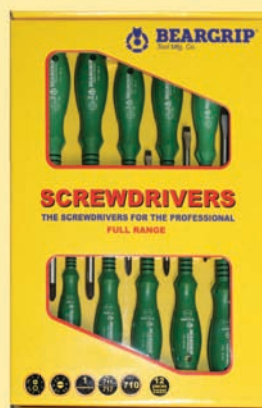

obj. kód	mm	velkosti	ks
34353	☉	2,5 - 3 - 4 - 5,5 - 6,5 - 8	12
	⊕	Ph.1 - 2 - 3	
	⊕	Pd.1 - 2 - 3	

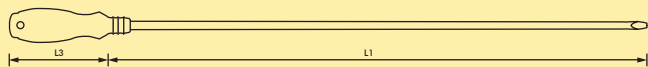

Beargrip s.r.o.
 Kollárova 88
 03601 Martin
 Slovakia
 T: +421 434 003 605
 F: +421 434 003 604
 E: mail@beargrip.com
 I: www.beargrip.com

⊖ = 710XL SKRUTKOVAČE EXTRA DLHÉ, PLOCHÉ, ISO 2380 (DIN 5265)
 JEDNOKOMPONENTNÁ ZELENÁ RUKOVÄŤ



	obj. kód	L1		Ø	L3
mm		mm	mm	mm	mm
5,5	34474	510	1,0	5,5	100



⊕ = 711XL SKRUTKOVAČE EXTRA DLHÉ, KRÍŽOVÉ, ISO 2764 (DIN 5262)
 JEDNOKOMPONENTNÁ ZELENÁ RUKOVÄŤ

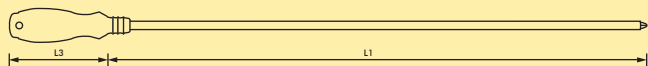

	obj. kód	L1		Ø	L3
		mm		mm	mm
Ph.2	34475	510		6	100



⊖⊕ = 727XL SADA NA BLISTRI



obj. kód	mm	velkosti	ks
34352	⊖	5,5	
	⊕	Ph.2	2

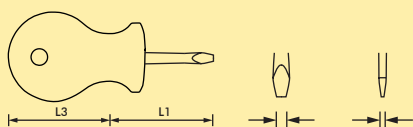

SKRUTKOVAČE

⊖ = 702 MINI SKRUTKOVAČE PLOCHÉ, ISO 2380 (DIN 5265)
JEDNOKOMPONENTNÁ ZELENÁ RUKOVÄŤ



	obj. kód	L1		Ø	L3
mm		mm	mm	mm	mm
4	31803	25	0,8	4	50
5,5	31804	25	1,0	5,5	50
6,5	31805	25	1,2	6,5	50



⊕ = 703 MINI SKRUTKOVAČE KRÍŽOVÉ, ISO 2764 (DIN 5262)
JEDNOKOMPONENTNÁ ZELENÁ RUKOVÄŤ

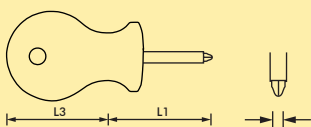

	obj. kód	L1		Ø	L3
		mm		mm	mm
Ph.1	31806	25		5	50
Ph.2	31807	25		6	50



⊕ = 704 MINI SKRUTKOVAČE KRÍŽOVÉ, ISO 8764 (DIN 5262)
JEDNOKOMPONENTNÁ ZELENÁ RUKOVÄŤ

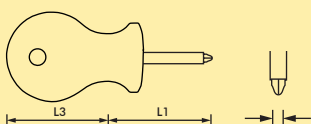

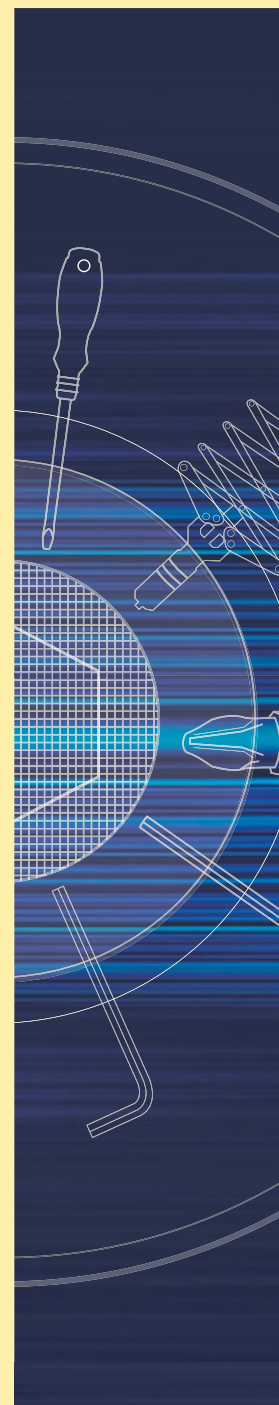

	obj. kód	L1		Ø	L3
		mm		mm	mm
Pd.1	31808	25		5	50
Pd.2	31809	25		6	50

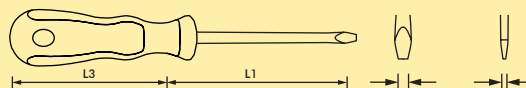

Beargrip s.r.o.
Kollárova 88
03601 Martin
Slovakia
T: +421 434 003 605
F: +421 434 003 604
E: mail@beargrip.com
I: www.beargrip.com

⊖ = 770 SKRUTKOVAČE PLOCHÉ, ISO 2380 (DIN 5265)
DVOJKOMPONENTNÁ ZELENO-ČIERNÁ RUKOVÄŤ



	obj. kód	L1		Ø	L3
mm		mm	mm	mm	mm
2,5	31810	75	0,4	2,5	85
3	31811	100	0,5	3	85
4	31812	100	0,8	4	95
5,5	31813	125	1,0	5,5	105
6,5	31814	150	1,2	6,5	105
8	31815	175	1,2	8	120
10	31816	200	1,6	10	120
12	31817	250	1,6	12	120



⊕ = 771 SKRUTKOVAČE KRÍŽOVÉ, ISO 2764 (DIN 5262)
DVOJKOMPONENTNÁ ZELENO-ČIERNÁ RUKOVÄŤ

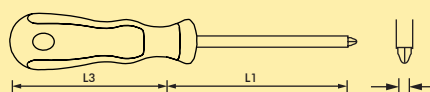

	obj. kód	L1		Ø	L3
		mm		mm	mm
Ph.0	31818	60		3,5	85
Ph.1	31819	80		5	95
Ph.1	31820	250		5	95
Ph.2	31821	100		6	105
Ph.2	31822	250		6	105
Ph.3	31823	150		8	120
Ph.4	31824	200		10	120



⊕ = 780 SKRUTKOVAČE KRÍŽOVÉ, ISO 8764 (DIN 5262)
DVOJKOMPONENTNÁ ZELENO-ČIERNÁ RUKOVÄŤ

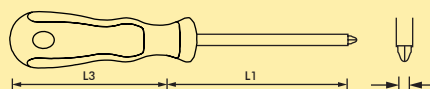



	obj. kód	L1		Ø	L3
		mm		mm	mm
Pd.0	31825	60		3,5	85
Pd.1	31826	80		5	95
Pd.1	31827	250		5	95
Pd.2	31828	100		6	105
Pd.2	31829	250		6	105
Pd.3	31830	150		8	120



SKRUTKOVAČE



SADY V KRABICI

 = 735

obj. kód		velkosti	ks
31907		4 - 5,5 - 6,5	
		Ph.1 - 2	5



 = 740



obj. kód		velkosti	ks
31908		4 - 5,5 - 6,5	
		Pd.1 - 2	5

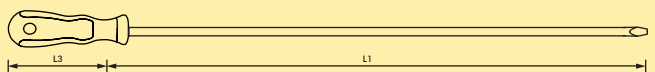

Beargrip s.r.o.
 Kollárova 88
 03601 Martin
 Slovakia
 T: +421 434 003 605
 F: +421 434 003 604
 E: mail@beargrip.com
 I: www.beargrip.com

⊖ = 770XL SKRUTKOVAČE EXTRA DLHÉ, PLOCHÉ, ISO 2380 (DIN 5265)
DVOJKOMPONENTNÁ ZELENO-ČIERNA RUKOVÄŤ



	obj. kód	L1		Ø	L3
mm		mm	mm	mm	mm
5,5	34472	510	1,0	5,5	100



⊕ = 771XL SKRUTKOVAČE EXTRA DLHÉ, KRÍŽOVÉ, ISO 2764 (DIN 5262)
DVOJKOMPONENTNÁ ZELENO-ČIERNA RUKOVÄŤ

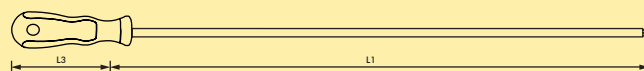

	obj. kód	L1		Ø	L3
		mm		mm	mm
Ph.2	34473	510		6	100



⊖⊕ = 737XL SADA NA BLISTRI



obj. kód		velkosti	ks
34478	⊖	5,5	
	⊕	Ph.2	2

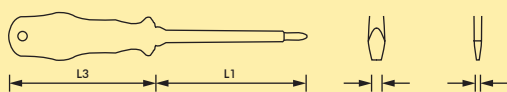

SKRUTKOVAČE

⊖ = 714 SKRUTKOVAČE PLOCHÉ ELEKTRIKÁRSKE, 1000V - EN 60900
JEDNOKOMPONENTNÁ ČERVENÁ RUKOVÄŤ



	obj. kód	L1		∅	L3
mm		mm	mm	mm	mm
2,5	31850	75	0,4	2,5	70
3	31851	100	0,5	3	70
4	31852	100	0,8	4	90
5,5	31853	125	1,0	5,5	100
6,5	31854	150	1,2	6,5	100
8	31855	175	1,2	7	110
10	31856	200	1,6	8	110



⊕ = 716 SKRUTKOVAČE KRÍŽOVÉ ELEKTRIKÁRSKE, 1000V - EN 60900
JEDNOKOMPONENTNÁ ČERVENÁ RUKOVÄŤ

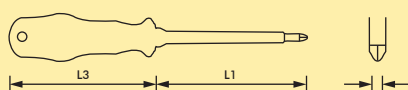

	obj. kód	L1		∅	L3
		mm		mm	mm
Ph.0	31857	60		3,5	80
Ph.1	31858	80		5	90
Ph.2	31859	100		6	100
Ph.3	31860	150		8	110



⊕ = 721 SKRUTKOVAČE KRÍŽOVÉ ELEKTRIKÁRSKE, 1000V - EN 60900
JEDNOKOMPONENTNÁ ČERVENÁ RUKOVÄŤ

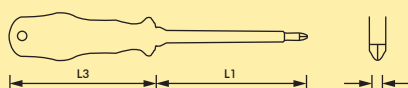



	obj. kód	L1		∅	L3
		mm		mm	mm
Pd.0	31861	60		3,5	80
Pd.1	31862	80		5	90
Pd.2	31863	100		6	100



Beargrip s.r.o.
 Kollárova 88
 03601 Martin
 Slovakia
 T: +421 434 003 605
 F: +421 434 003 604
 E: mail@beargrip.com
 I: www.beargrip.com



SADY V KRABICI

 = 726

obj. kód		velkosti	ks
31913		3 - 4 - 5,5	
		Ph.1 - 2	5



 = 731



obj. kód		velkosti	ks
31914		3 - 4 - 5,5	
		Pd.1 - 2	5

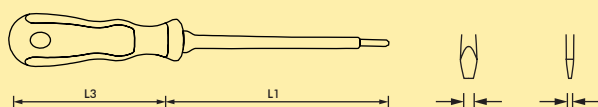

SKRUTKOVÁČE

⊖ = 774 SKRUTKOVAČE PLOCHÉ ELEKTRIKÁRSKE, 1000V - EN 60900
DVOJKOMPONENTNÁ ČERVENO-ŽLTÁ RUKOVÄŤ



	obj. kód	L1		∅	L3
mm		mm	mm	mm	mm
2,5	31866	75	0,4	2,5	85
3	31867	100	0,5	3	85
3,5	31868	100	0,6	3,5	85
4	31869	100	0,8	4	95
5,5	31870	125	1,0	5,5	105
6,5	31871	150	1,2	6,5	105
8	31872	175	1,2	8	120
10	31873	200	1,6	10	120



⊕ = 776 SKRUTKOVAČE KRÍŽOVÉ ELEKTRIKÁRSKE, 1000V - EN 60900
DVOJKOMPONENTNÁ ČERVENO-ŽLTÁ RUKOVÄŤ

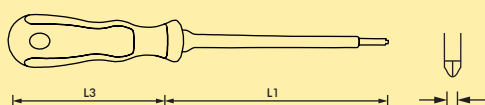

	obj. kód	L1		∅	L3
		mm		mm	mm
Ph.0	31874	60		3,5	85
Ph.1	31875	80		5	95
Ph.2	31876	100		6	105
Ph.3	31877	150		8	120
Ph.4	31878	200		10	120



⊕ = 781 SKRUTKOVAČE KRÍŽOVÉ ELEKTRIKÁRSKE, 1000V - EN 60900
DVOJKOMPONENTNÁ ČERVENO-ŽLTÁ RUKOVÄŤ

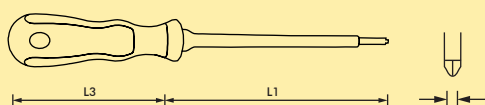

	obj. kód	L1		∅	L3
		mm		mm	mm
Pd.0	31879	60		3,5	85
Pd.1	31880	80		5	95
Pd.2	31881	100		6	105
Pd.3	31882	150		8	120



Beargrip s.r.o.
Kollárova 88
03601 Martin
Slovakia
T: +421 434 003 605
F: +421 434 003 604
E: mail@beargrip.com
I: www.beargrip.com

SADY V KRABICI

= 736

obj. kód		velkosti	ks
31915		3 - 4 - 5,5	
		Ph.1 - 2	5



= 741

obj. kód		velkosti	ks
31916		3 - 4 - 5,5	
		Pd.1 - 2	5



= 736MAX

obj. kód		velkosti	ks
32696		2,5 - 3,5 - 4 - 5,5	
		Ph.1 - 2	
		+ skúšačka	7



= 741MAX

obj. kód		velkosti	ks
32611		2,5 - 3 - 4 - 5,5	
		Pd.1 - 2	
		+ skúšačka	7



SKRUTKOVÁČE

+ = 718 ŠPECIÁLNE ELEKTRIKÁRSKE SKRUTKOVAČE PLUSMINUS, 1000V - EN 60900, DVOJKOMPONENTNÁ ČERVENO-ORANŽOVÁ RUKOVÄŤ

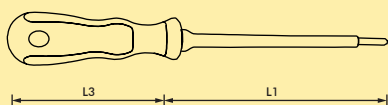

	obj. kód	L1		Ø	L3
		mm		mm	mm
5	32480	80		5	95
6	32481	100		6	105



SADA NA BLISTRI

+ = 738

obj. kód		veľkosti	ks
32500	+	Pd. 1 - 2	2



□ = 713 ŠPECIÁLNE ELEKTRIKÁRSKE SKRUTKOVAČE, 1000V - EN 60900 JEDNOKOMPONENTNÁ ČERVENÁ RUKOVÄŤ

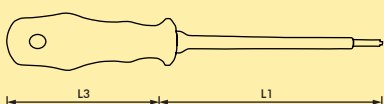

	obj. kód	L1		Ø	L3
		mm		mm	mm
3,5	31864	100		3,5	78
6,5	31865	150		6,5	98



SADA NA BLISTRI

□ = 733

obj. kód		veľkosti	ks
32499	□	3,5 - 6,5	2



Beargrip s.r.o.
 Kollárova 88
 03601 Martin
 Slovakia
 T: +421 434 003 605
 F: +421 434 003 604
 E: mail@beargrip.com
 I: www.beargrip.com

3010 1/4" FLEXIBILNÝ SKRUTKOVÁČ NA BITY

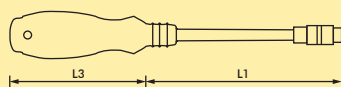

výstup	obj. kód balenie blister	obj. kód	L1 mm	L3 mm
1/4"	30563	31376	210	110



3013 1/4" MAGNETICKÉ SKRUTKOVÁČE NA BITY

JEDNOKOMPONENTNÁ ZELENÁ T-RUKOVÄŤ, CHRÓMOVANÉ TELO

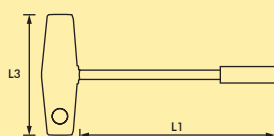

výstup	obj. kód	L1 mm	L3 mm
1/4"	31377	45	90
1/4"	31250	150	90



3015 PEVNÝ MAGNETICKÝ SKRUTKOVÁČ NA BITY

JEDNOKOMPONENTNÁ ZELENÁ PRIAMA RUKOVÄŤ, CHRÓMOVANÉ TELO

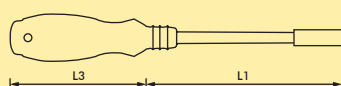

výstup	obj. kód	L1 mm	L3 mm
1/4"	34616	170	110



3015 PEVNÝ MAGNETICKÝ SKRUTKOVÁČ NA BITY

DOVKOMPONENTNÁ ZELENÁ PRIAMA RUKOVÄŤ, CHRÓMOVANÉ TELO

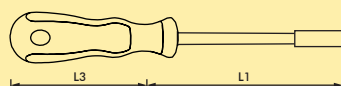

výstup	obj. kód	L1 mm	L3 mm
1/4"	32526	170	110



SKRUTKOVÁČE

⊖ = 3012 1/4" MAGNETICKÝ RAČŇOVÝ SKRUTKOVÁČ NA BITY,
DVOJKOMPONENTNÁ ZELENO-ČIERNA RUKOVÄŤ, CHRÓMOVANÉ TELO

ĽAVÝ - PRAVÝ CHOD + FIXÁCIA

výstup	obj. kód	L1 mm	L3 mm
1/4"	30541	105	125



⊖ ⊕ = 3027 1/4" MAGNETICKÝ RAČŇOVÝ SKRUTKOVÁČ NA BITY
+ SADA BITOV V PLASTOVÝCH BITBLOK KOCKÁCH
DVOJKOMPONENTNÁ ZELENO-ČIERNA RUKOVÄŤ, CHRÓMOVANÉ TELO

výstup	obj. kód	L1 mm	L3 mm
1/4"	30542	105	125



22 bitov
22 bits

⊖	1 x 3 - 4 - 5 - 6 - 7 - 8
⊕	1 x Ph.1 - Ph.3 / 2 x Ph.2
⊕	1 x Pd.1 - Pd.3 / 2 x Pd.2
⊗	1 x Tx. 9 - 10 - 15 - 20
	25 - 27 - 30 - 40



Beargrip s.r.o.
Kollárova 88
03601 Martin
Slovakia
T: +421 434 003 605
F: +421 434 003 604
E: mail@beargrip.com
I: www.beargrip.com

MM = 760
INCH = 761

SKRUTKOVAČE SO ŠEŠŤ HRANNOU HLAVICOU
JEDNOKOMPONENTNÁ ZELENÁ T-RUKOVÄŤ, CHRÓMOVANÉ TELO

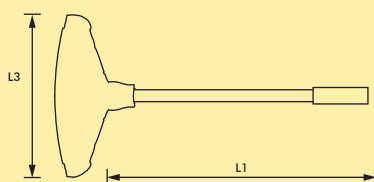

Ø	obj. kód	L1	L3
mm		mm	mm
5	31756	230	109
5,5	31757	230	109
6	31758	230	109
7	31759	230	109
8	31760	230	109
9	31761	230	109
10	33381	230	109
11	31762	230	109
12	31763	230	109
13	31764	230	109
14	31765	230	109
17	31705	230	109

Ø	obj. kód	L1	L3
inch		inch	inch
7/32	31766	230	109
1/4	31767	230	109
9/32	31768	230	109
5/16	31769	230	109
11/32	31770	230	109
3/8	31771	230	109
7/16	31772	230	109
1/2	31773	230	109
9/16	31774	230	109
5/8	31775	230	109

SADA V KRABICI

⊙ = 760

obj. kód	mm	veľkosti	ks
34356	⊙	5,5 - 7 - 8 - 10 - 13 - 17	6



SKRUTKOVAČE

E = 764 SKRUTKOVAČE S HLAVICOU "E"
JEDNOKOMPONENTNÁ ZELENÁ RUKOVÄŤ

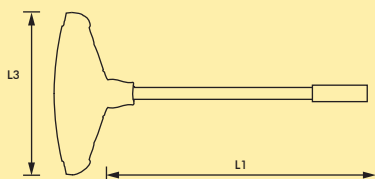

E	obj. kód	L1		L3
		mm		mm
E6	31776	230		109
E7	31777	230		109
E8	31778	230		109
E10	31779	230		109
E12	31780	230		109
E14	31781	230		109
E16	31782	230		109



O = 763 FLEXIBILNÉ SKRUTKOVAČE SO ŠEŠŤ HRANNOU HLAVICOU
JEDNOKOMPONENTNÁ ZELENÁ RUKOVÄŤ

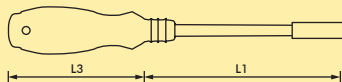

	obj. kód	L1	Ø	L3
		mm	mm	mm
6	33957	150	6	105
7	33958	150	7	105
8	33959	152	8	105
10	33960	158	10	105



SADA V KRABICI

O = 763

obj. kód	mm	velkosti	ks
34354	O	6 - 7 - 8 - 10	4



Beargrip s.r.o.
Kollárova 88
03601 Martin
Slovakia
T: +421 434 003 605
F: +421 434 003 604
E: mail@beargrip.com
I: www.beargrip.com

758 FLEXIBILNÝ MAGNET S PAMÄŤOVÝM KRKOM
JEDNOKOMPONENTNÁ ZELENÁ RUKOVÄŤ

NASTAVITEĽNÝ TVAR DRIEKU
 PEVNÁ PRUŽINA
 SILNÝ NEODNÍMATEĽNÝ MAGNET

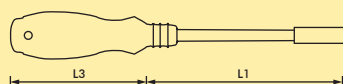

	obj. kód	L1	nosnosť	Ø	L3
		mm	g	mm	mm
5	32495	430	27	5	75
8	32493	430	92	8	90
12	32494	430	94	12	90



759 PRÍPRAVKY NA ODIHLENIE HRÁN
DVOJKOMPONENTNÁ ZELENO-ČIERNA RUKOVÄŤ

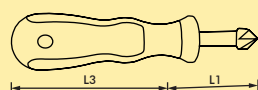

	obj. kód	L1	Ø	L3
		mm	mm	mm
12	30036	35	12	100
16	30037	35	16	100



○ = 3016 1/4" NEREZOVÉ MAGNETICKÉ DRŽIAKY BITOV, TELO S ISTIACOU PRUŽINOU

obj. kód	obj. kód balenie blister	L mm
31258	30464	60
31378	32660	75
31379	32661	125
31380	32662	180

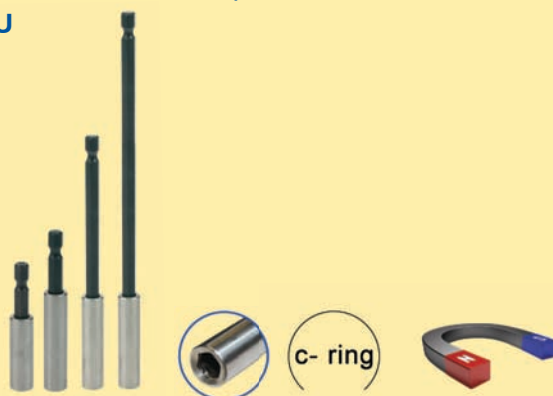

○ = 3016 1/4" NEREZOVÝ MAGNETICKÝ DRŽIAK BITOV, ÚDEROVÝ

VHODNÝ PRE ELEKTRICKÉ A PNEUMATICKÉ ZARIADENIA S PRÍKLEPOM.

obj. kód	L mm
31979	80

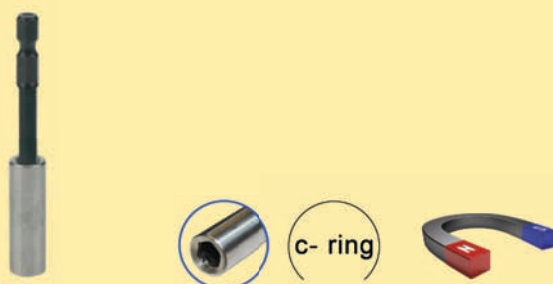

○ 1/4" NEREZOVÝ MAGNETICKÝ DRŽIAK BITOV

S FUNKCIU PRIDRŽANIA SKRUTKY

obj. kód	L mm	upnutie	Ø mm
11230	65	1/4"	13
34683	65	1/4"	17
16217	84	SDS	11



○ = 3018 1/4" NEREZOVÝ MAGNETICKÝ DRŽIAK BITOV

FLEXIBILNÝ, S FUNKCIU PRIDRŽANIA SKRUTKY

obj. kód	L mm
31895	225

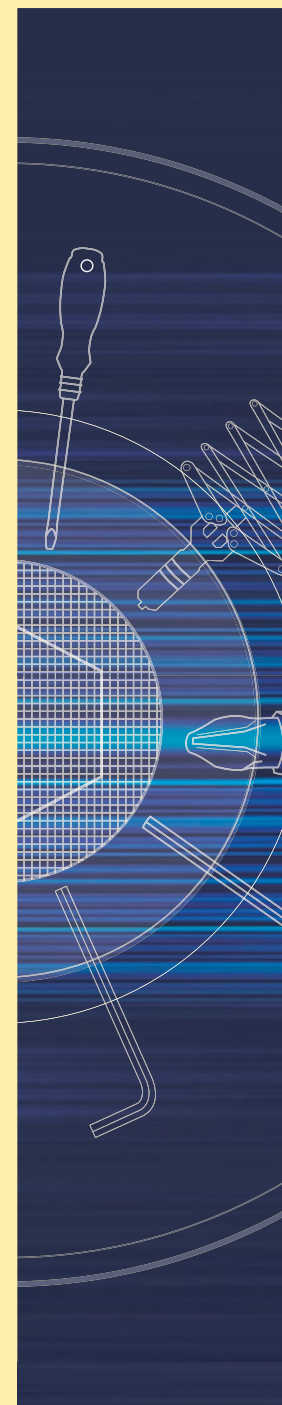

Beargrip s.r.o.
Kollárova 88
03601 Martin
Slovakia
T: +421 434 003 605
F: +421 434 003 604
E: mail@beargrip.com
I: www.beargrip.com

☐ - ○ = 3011 1/4" PREVODNÍKY

obj. kód	L mm
34610	25
34611	50



○ 3020 1/4" HĽBKOVÝ NASTAVITEĽNÝ OBMEDZOVAČ S DRŽIAKOM

obj. kód	L mm
31382	70



○ = 4009 1/4" MAGNETICKÝ NADSTAVEC

obj. kód	obj. kód balenie blister	L mm
31419	32664	4
34612	32665	5
31420	32666	5,5
31421	32667	6
31422	32668	7
31423	32669	8
2514	32670	9
31424	32671	10
31425	32672	11
31426	32673	12
31427	32674	13
32752	34613	14

obj. kód	obj. kód balenie blister	L inch
31428	32675	1/4
31429	32676	3/8



○ = 4009 1/4" MAGNETICKÝ NADSTAVEC

obj. kód	○	veľkosti	ks
31418	mm	5 - 5,5 - 6 - 7 - 8 - 9 - 10 - 11 - 12 - 13	
	inch	1/4 - 3/8"	12



BITY

ŠTANDARDNÉ BITY

● = 3001

obj. kód balenie PVC kazeta 1 ks	obj. kód balenie blister 3ks	obj. kód balenie bitblok 2 bity	●	mm
32232	31284	31290	3 x 0,5	25
32233	31285	31291	4 x 0,6	25
32234	31286	31292	5 x 0,8	25
32235	31287	31293	6 x 1	25
32236	31288	31294	7 x 1	25
32237	31289	31295	8 x 1,2	25



○ = 3005

obj. kód balenie PVC kazeta 1 ks	obj. kód balenie blister 3ks	obj. kód balenie bitblok 2 bity	○	mm
32255	-	31346	No. 1	25
32256	-	31347	No. 2	25
32257	-	31348	No. 3	25



⊕ = 3002

obj. kód balenie PVC kazeta 1 ks	obj. kód balenie blister 3ks	obj. kód balenie bitblok 2 bity	⊕	mm
32238	31305	31318	Ph.0	25
32239	31306	31319	Ph.1	25
32240	31308	31320	Ph.2	25
32241	31310	31321	Ph.3	25
32242	31311	31322	Ph.4	32



⊕ = 3006

obj. kód balenie PVC kazeta 1 ks	obj. kód balenie blister 3ks	obj. kód balenie bitblok 2 bity	⊕	mm
33254	33251	-	TX5	25
33255	33252	-	TX6	25
33256	33253	-	TX7	25
32258	31360	31366	TX8	25
32259	31361	31367	TX9	25
32260	31362	31368	TX10	25
32261	31363	31369	TX15	25
32262	31364	31370	TX20	25
32263	31365	31371	TX25	25
32264	-	31372	TX27	25
32265	-	31373	TX30	25
32266	-	31374	TX40	25
32267	-	31375	TX45	25
32268	-	-	TX50	25
32269	-	-	TX55	25



⊕ = 3003

obj. kód balenie PVC kazeta 1 ks	obj. kód balenie blister 3ks	obj. kód balenie bitblok 2 bity	⊕	mm
32243	31312	31323	Pd.1	25
32244	31314	31324	Pd.2	25
32245	31316	31325	Pd.3	25
32246	31317	31326	Pd.3	32



○ = 3004

obj. kód balenie PVC kazeta 1 ks	obj. kód balenie blister 3ks	obj. kód balenie bitblok 2 bity	○	mm
32247	-	31335	2,5	25
32248	-	31336	3	25
32249	-	31337	4	25
32250	-	31338	5	25
32251	-	31339	6	25
32252	-	31340	7	25
32253	-	31341	8	25
32254	-	31342	10	25



⊕ = 3006R

obj. kód balenie PVC kazeta 1 ks	obj. kód balenie blister 3ks	obj. kód balenie bitblok 2 bity	R	mm
32270	-	31455	TX9	25
32271	-	31456	TX10	25
32272	-	31457	TX15	25
32273	-	31458	TX20	25
32274	-	31459	TX25	25
32275	-	31460	TX27	25
32276	-	31461	TX30	25
32277	-	31462	TX40	25



Beargrip s.r.o.
Kollárova 88
03601 Martin
Slovakia
T: +421 434 003 605
F: +421 434 003 604
E: mail@beargrip.com
I: www.beargrip.com

ZIRKÓNOVÉ BITY, POVRCHOVO UPRAVENÉ

 = 3006PLS

obj. kód balenie PVC kazeta 1 ks	obj. kód balenie blister 3ks	obj. kód balenie bulk	PLS 	mm
-	-	33437	TX5	25
-	-	33438	TX6	25
-	-	33439	TX7	25
-	-	33440	TX8	25
-	-	33441	TX9	25
-	-	33442	TX10	25
-	-	33443	TX15	25
-	-	33444	TX20	25
-	-	33445	TX25	25
-	-	33446	TX27	25
-	-	33447	TX30	25
-	-	33448	TX40	25

 = 3001

obj. kód balenie PVC kazeta 1 ks	obj. kód balenie blister 3ks	obj. kód balenie bitblok 2 bity	Zr. N 	mm
-	-	-	3 x 0,5	25
32284	-	-	4 x 0,6	25
32285	-	-	5 x 0,8	25
32286	-	-	6 x 1	25
32287	-	-	7 x 1	25

 = 3002

obj. kód balenie PVC kazeta 1 ks	obj. kód balenie blister 3ks	obj. kód balenie bitblok 2 bity	Zr.N 	mm
32288	-	-	Ph.1	25
32289	-	-	Ph.2	25
32290	-	-	Ph.3	25

 = 3007IP

obj. kód balenie PVC kazeta 1 ks	obj. kód balenie blister 3ks	obj. kód balenie bulk	R 	mm
-	-	33474	TX10	25
-	-	33475	TX15	25
-	-	33476	TX20	25
-	-	33477	TX25	25
-	-	33479	TX27	25
-	-	33480	TX30	25
-	-	33481	TX40	25

 = 3003

obj. kód balenie PVC kazeta 1 ks	obj. kód balenie blister 3ks	obj. kód balenie bitblok 2 bity	Zr.N 	mm
32291	-	-	Pd.1	25
32292	-	-	Pd.2	25
32293	-	-	Pd.3	25

TITANOVÉ BITY, POVRCHOVO UPRAVENÉ

 = 3002

obj. kód balenie PVC kazeta 1 ks	obj. kód balenie blister 3ks	obj. kód balenie bitblok 2 bity	Ti.N 	mm
32278	-	31478	Ph.1	25
32279	31474	31479	Ph.2	25
32280	-	31480	Ph.3	25

 = 3006

obj. kód balenie PVC kazeta 1 ks	obj. kód balenie blister 3ks	obj. kód balenie bitblok 2 bity	Zr.N 	mm
32294	-	-	TX8	25
32295	-	-	TX9	25
32296	-	-	TX10	25
32297	-	-	TX15	25
32298	-	-	TX20	25
32299	-	-	TX25	25
32300	-	-	TX27	25
32301	-	-	TX30	25
32302	-	-	TX40	25

 = 3003

obj. kód balenie PVC kazeta 1 ks	obj. kód balenie blister 3ks	obj. kód balenie bitblok 2 bity	Ti.N 	mm
32281	31475	31481	Pd.1	25
32282	31476	31482	Pd.2	25
32283	31477	31483	Pd.3	25

BITY

BITY S DIAMANTOVÝM ŠPICOM

POVRCHOVO UPRAVENÉ

+ = 3002

obj. kód balenie PVC kazeta 1 ks	obj. kód balenie blister 3ks	obj. kód balenie bitblok 2 bity	diamantový špic +	mm
33583	33565	-	Ph.1	25
33573	33556	-	Ph.2	25
33584	33566	-	Ph.3	25



+ = 3003

obj. kód balenie PVC kazeta 1 ks	obj. kód balenie blister 3ks	obj. kód balenie bitblok 2 bity	diamantový špic +	mm
33585	33567	-	Pd.1	25
33574	33557	-	Pd.2	25
33586	33568	-	Pd.3	25



+ = 3006

obj. kód balenie PVC kazeta 1 ks	obj. kód balenie blister 3ks	obj. kód balenie bitblok 2 bity	diamantový špic +	mm
33575	33558	-	TX10	25
33576	33559	-	TX15	25
33577	33560	-	TX20	25
33578	33561	-	TX25	25
33579	33562	-	TX27	25
33580	33563	-	TX30	25
33582	33564	-	TX40	25



TORZNÉ BITY

+ = 3002

obj. kód balenie PVC kazeta 1 ks	obj. kód balenie blister 3ks	obj. kód balenie bitblok 2 bity	torzný hrubý +	mm
34220	-	34362	Ph.1	25
34222	-	34363	Ph.2	25
34224	-	34364	Ph.3	25



+ = 3003

obj. kód balenie PVC kazeta 1 ks	obj. kód balenie blister 3ks	obj. kód balenie bitblok 2 bity	torzný hrubý +	mm
34226	-	34365	Pd.1	25
34228	-	34366	Pd.2	25
34230	-	34367	Pd.3	25



+ = 3006

obj. kód balenie PVC kazeta 1 ks	obj. kód balenie blister 3ks	obj. kód balenie bitblok 2 bity	torzný +	mm
31948	-	-	TX10	25
31949	-	-	TX15	25
31950	-	-	TX20	25
31951	-	-	TX25	25
31952	-	-	TX27	25
31953	-	-	TX30	25
31954	-	-	TX40	25



TORZNÉ BITY Ti.N, POVRCHOVO UPRAVENÉ

+ = 3002

obj. kód balenie PVC kazeta 1 ks	obj. kód balenie blister 3ks	obj. kód balenie bitblok 2 bity	torzný Ti.N hrubý +	mm
34201	-	34298	Ph.1	25
34203	-	34299	Ph.2	25
34205	-	34300	Ph.3	25



+ = 3003

obj. kód balenie PVC kazeta 1 ks	obj. kód balenie blister 3ks	obj. kód balenie bitblok 2 bity	torzný Ti.N hrubý +	mm
34207	-	34301	Pd.1	25
34210	-	34302	Pd.2	25
34212	-	34303	Pd.3	25



ÚDEROVÉ BITY, ŠPECIÁLNE ZAKALENÝ DRIEK, VHDNÉ PRE PNEUMATICKÉ A ELEKTRICKÉ ZARIADENIA

+ = 3002

obj. kód balenie PVC kazeta 1 ks	obj. kód balenie blister 3ks	obj. kód balenie bitblok 2 bity	úderový +	mm
31958	-	-	Ph.1	30
31959	-	-	Ph.2	30
31960	-	-	Ph.3	30



+ = 3003

obj. kód balenie PVC kazeta 1 ks	obj. kód balenie blister 3ks	obj. kód balenie bitblok 2 bity	úderový +	mm
31964	-	-	Pd.1	30
31965	-	-	Pd.2	30
31966	-	-	Pd.3	30



Beargrip s.r.o.
Kollárova 88
03601 Martin
Slovakia
T: +421 434 003 605
F: +421 434 003 604
E: mail@beargrip.com
I: www.beargrip.com

PREDĽŽENÉ BITY

⊖ = 4001

obj. kód balenie PVC kazeta 1 ks	obj. kód balenie PE sáčok	⊖	mm
32303	31393	3 x 0,5	50
32304	31394	4 x 0,6	50
32305	31395	4,5 x 0,6	50
32306	31396	5 x 0,8	50
32307	31397	5,5 x 0,8	50
32308	31398	6 x 1	50
32309	31399	7 x 1	50
32310	31400	8 x 1,2	50



○ = 4004

obj. kód balenie PVC kazeta 1 ks	obj. kód balenie PE sáčok	○	mm
31408	32318	2,5	50
31409	32319	3	50
31410	32320	4	50
31411	32321	5	50
31412	32322	6	50
31413	32323	7	50
31414	32324	8	50



⊕ = 4002

obj. kód balenie PVC kazeta 1 ks	obj. kód balenie PE sáčok	⊕	mm
32311	31401	Ph.0	50
32312	31402	Ph.1	50
32313	31403	Ph.2	50
32314	31404	Ph.3	50

obj. kód balenie PVC kazeta 1 ks	obj. kód balenie PE sáčok	⊕	mm
-	31437	Ph.1	75
-	31438	Ph.2	75
-	31439	Ph.3	75

obj. kód balenie PVC kazeta 1 ks	obj. kód balenie PE sáčok	⊕	mm
-	31443	Ph.1	100
-	31444	Ph.2	100
-	31445	Ph.3	100



□ = 4005

obj. kód balenie PVC kazeta 1 ks	obj. kód balenie PE sáčok	□	mm
32325	31415	No. 1	50
32326	31416	No. 2	50
32327	31417	No. 3	50



⊛ = 4006

obj. kód balenie PVC kazeta 1 ks	obj. kód balenie PE sáčok	⊛	mm
32328	-	TX8	50
32329	-	TX9	50
32330	31430	TX10	50
32331	31431	TX15	50
32332	31432	TX20	50
32333	31433	TX25	50
32334	31434	TX27	50
32335	31435	TX30	50
32336	31436	TX40	50



⊕ = 4003

obj. kód balenie PVC kazeta 1 ks	obj. kód balenie PE sáčok	⊕	mm
32315	31405	Pd.1	50
32316	31406	Pd.2	50
32317	31407	Pd.3	50

obj. kód balenie PVC kazeta 1 ks	obj. kód balenie PE sáčok	⊕	mm
-	31440	Pd.1	75
-	31441	Pd.2	75
-	31442	Pd.3	75

obj. kód balenie PVC kazeta 1 ks	obj. kód balenie PE sáčok	⊕	mm
-	31446	Pd.1	100
-	31447	Pd.2	100
-	31448	Pd.3	100



⊛ = 4006R

obj. kód balenie PVC kazeta 1 ks	obj. kód balenie PE sáčok	R	mm
32337	31463	TX8	50
32338	31464	TX9	50
32339	31465	TX10	50
32340	31466	TX15	50
32341	31467	TX20	50



BITY

**ÚDEROVÉ BITY PREDĹŽENÉ, ŠPECIÁLNE ZAKALENÝ DRIEK,
VHODNÉ PRE PNEUMATICKÉ A ELEKTRICKÉ ZARIADENIA**

⊕ = 4002

obj. kód balenie PVC kazeta 1 ks	obj. kód balenie PE sáčok	úderový ⊕	mm
31970	31967	Ph.1	50
31971	31968	Ph.2	50
31972	31969	Ph.3	50



⊕ = 4003

obj. kód balenie PVC kazeta 1 ks	obj. kód balenie PE sáčok	úderový ⊕	mm
31976	31973	Pd.1	50
31977	31974	Pd.2	50
31978	31975	Pd.3	50



⊕ = 500

DREVENÁ PREZENTAČNÁ KAZETA BITOV

séria	obj. kód balenie PE sáčok		mm	ks
3001	31279	⊖	4	50
3001	31280	⊖	5	50
3001	31281	⊖	6	50
3001	31282	⊖	7	50
3002	31297	⊕	Ph.1	100
3002	31298	⊕	Ph.2	100
3003	31301	⊕	Pd.1	50
3003	31302	⊕	Pd.2	50
3016	31258	⊙	60	10

500 31218 plná - 510 ks
500 32731 prázdna



PREDNOSTI BITOV BEARGRIP

Bity Beargrip z triedy PH1, PH2, PD1 a PD2 súvo všetkých povrcho-
vých úpravách vyrábané unikátnou technológiou rotačného kovania
za studena, kde je profil bitu tvarovaný údermi kladiviek, rotujúcich
okolo osi bitu, pričom dochádza k zhutneniu materiálu v mieste špičky
a neporušeniu vlákien oproti štandardne vyrobeným bitom na CNC
obrábacích centrách, ktoré redukujú priemer a tvarujú špičku len odo-
beraním materiálu. Táto technológia sa používa v automobilovom pri-
mysle, pri výrobe odľahčených poloosí, predných vidlíc motocyklov,
všade tam, kde je potreba redukovať hmotnosť a zvyšovať kvalitu
materiálu.



Beargrip s.r.o.
Kollárova 88
03601 Martin
Slovakia
T: +421 434 003 605
F: +421 434 003 604
E: mail@beargrip.com
I: www.beargrip.com

BITY V SADÁCH



- PREHLADNÉ SKLÁPACIE PÚZDRO
- KOMFORTNÉ OTVÁRANIE A ZATVÁRANIE
- JEDNODUCHÁ VÝMENA BITOV
- MOŽNOSŤ ZAVESENIA: NA OPASOK, NA PREDAJNI

ClipPac SADY BITOV S MAGNETICKÝM DRŽIAKOM BITOV 3016 - 60 MM

7- dielne verzie

+	+	séria	obj. kód		sada obsahuje
		3043/7	30405	-	5 - 7
				+	Ph.1 - Ph.2
				+	Pd.1 - Pd.2
					držiak bitov 3016 - 60 mm

+	+	séria	obj. kód		sada obsahuje
		3044/7	30330	+	Ph.1 - Ph.2 - Ph.3
				+	Pd.1 - Pd.2 - Pd.3
					držiak bitov 3016 - 60 mm

+	+	séria	obj. kód		sada obsahuje
		3045/7	30547	+	2,5 - 3 - 4 - 5 - 6 - 8
					držiak bitov 3016 - 60 mm

+	+	séria	obj. kód		sada obsahuje
		3046/7	30380	+	Tx. 10 - 15 - 20 - 25 - 30 - 40
					držiak bitov 3016 - 60 mm

+	+	séria	obj. kód		sada obsahuje
		3047/7	30516	+	Tx.R 10 - 15 - 20 - 25 - 30 - 40
					držiak bitov 3016 - 60 mm

11- dielne verzie

+	+	séria	obj. kód		sada obsahuje
		3043/11	31272	-	4 - 5 - 6 - 7
				+	Ph.1 - Ph.2 - Ph.3
				+	Pd.1 - Pd.2 - Pd.3
					držiak bitov 3016 - 60 mm

+	+	séria	obj. kód		sada obsahuje
		3046/11	31273	+	1 x Tx. 9 - 10 - 15 - 40
				+	2 x Tx. 20 - 25 - 30
					držiak bitov 3016 - 60 mm

+	+	séria	obj. kód		sada obsahuje
		3047/11	31274	+	1 x Tx.R 9 - 10 - 15 - 40
				+	2 x Tx.R 20 - 25 - 30
					držiak bitov 3016 - 60 mm



ClipPac SADY BITOV S MAGNETICKÝM DRŽIAKOM BITOV 3016 - 60 MM ŠPECIÁLNA POVRCHOVÁ ÚPRAVA BITOV TITÁN-NITRID (Ti.N)

+	+	séria	obj. kód		sada obsahuje
		3044/7	31275	+	Ph.1 - Ph.2 - Ph.3
		Ti.N		+	Pd.1 - Pd.2 - Pd.3
					držiak bitov 3016 - 60 mm

+	+	séria	obj. kód		sada obsahuje
		3048/11	31276	+	10 x Ph.2
		Ti.N			držiak bitov 3016 - 60 mm

+	+	séria	obj. kód		sada obsahuje
		3049/11	31277	+	10 x Pd.2
		Ti.N			držiak bitov 3016 - 60 mm

ClipPac SADY BITOV S MAGNETICKÝM DRŽIAKOM BITOV 3016 - 60 MM ŠPECIÁLNA POVRCHOVÁ ÚPRAVA BITOV ZIRKÓN-NITRID (Zr.N)

+	+	séria	obj. kód		sada obsahuje
		3043/7	31500	-	5 - 7
		Zr.N		+	Ph.1 - Ph.2
				+	Pd.1 - Pd.2
					držiak bitov 3016 - 60 mm

+	+	séria	obj. kód		sada obsahuje
		3043/11	31502	+	Ph.1 - Ph.2 - Ph.3
		Zr.N		+	Pd.1 - Pd.2 - Pd.3
					držiak bitov 3016 - 60 mm

+	+	séria	obj. kód		sada obsahuje
		3044/7	31501	+	Ph.1 - Ph.2 - Ph.3
		Zr.N		+	Pd.1 - Pd.2 - Pd.3
					držiak bitov 3016 - 60 mm

Možnosť ďalších farebných prevedení na požiadanie



BITY

BITY

SADY NA BLISTRI

POPULÁRNE PREVEDENIA - MIX KOMBINÁCIÍ

10- dielne verzie

+**+** = 3060

obj. kód		sada obsahuje
31388	+	Ph.1 - Ph.2
	+	Pd.1 - Pd.2
	+	Tx. 15 - 20 - 25 - 27 - 30 - 40

-**+** = 3061

obj. kód		sada obsahuje
31389	-	4 - 5 - 6 - 7
	+	Ph.1 - 2 - 3
	+	Pd.1 - 2 - 3

+**+** = 3062

obj. kód		sada obsahuje
31390	+	5 x Ph.2
	+	5 x Pd.2

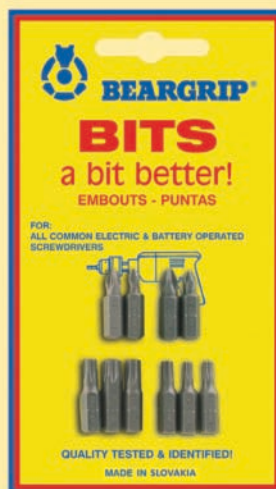

SADY BITOV + MAGNETICKÉ PREDĽŽENIE V BLISTROVOM BALENÍ

11- dielne verzie

+**+** = 3065

obj. kód		sada obsahuje
31391	+	Ph.1 - 2
	+	Pd.1 - 2
	+	Tx. 15 - 20 - 25 - 27 - 30 - 40
		držiak bitov 3016 - 60 mm

-**+** = 3066

obj. kód		sada obsahuje
31392	-	4 - 5 - 6 - 7
	+	Ph.1 - 2 - 3
	+	Pd.1 - 2 - 3
		držiak bitov 3016 - 60 mm

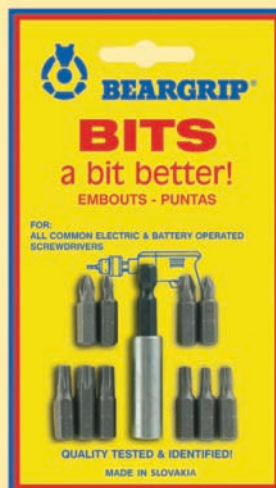

ORGANIZÉR NA BITY

Transparentná predná časť,
možnosť nalepenia popisov,
možné upnutie do regálu, alebo zavesenie na stenu.



34628 organizér na bity





Beargrip s.r.o.
Kollárova 88
03601 Martin
Slovakia
T: +421 434 003 605
F: +421 434 003 604
E: mail@beargrip.com
I: www.beargrip.com

  = 3030 ZÁSObNÍK BITOV BEARGRIP
JEDNOSTRANNÝ

PRAKTICKÉ PREZENTAČNÉ PANELY
BITOV ZATRAKTÍVŇUJÚ PREDAJNE
A PODPORUJÚ ODBYT.
FAREBNÉ ROZLIŠENIE BITBLOK KOCIEK
ZVÝŠUJE PREHLADNOSŤ, PRIŤAHUJE
POZORNOSŤ A UĽAHČUJE VÝBER.

JEDNOSTRANNÉ PREVEDENIE UMOŽŇU-
JE POLOŽENIE STOJANA NA PULT,
PRÍPADNE ZAVESENIE.

obj. kód		stojan obsahuje
31383		20 x 5 - 7
		20 x Ph.1 - Ph.2
		20 x Pd.1 - Pd.2





spolu 120 bitov = 60 bitblok kociek
Akákoľvek iná kompozícia na želanie je možná.



  = 3095 ZÁSObNÍK BITOV MARRY GO ROUND
TROJSTRANNÝ

PRAKTICKÉ PREZENTAČNÉ PANELY
BITOV ZATRAKTÍVŇUJÚ PREDAJNE
A PODPORUJÚ ODBYT.
FAREBNÉ ROZLIŠENIE BITBLOK KOCIEK
ZVÝŠUJE PREHLADNOSŤ, PRIŤAHUJE
POZORNOSŤ A UĽAHČUJE VÝBER.

TROJSTRANNÉ DÔMYSELNÉ PREVEDE-
NIE UMOŽŇUJE SKLADOVAŤ VEĽKÉ
MNOŽSTVO BITOV NA MALEJ PLOCHE,
MOŽNOSŤ OTÁČANIA.

obj. kód		stojan obsahuje
31484		20 x 5 - 7
		20 x Ph.0 - 1 - 2 - 3
		20 x Pd.1 - 2 - 3
		20 x Tx. 8 - 9 - 10 - 15 - 20 -25 27 - 30 - 40

spolu 360 bitov = 180 bitblok kociek
Akákoľvek iná kompozícia na želanie je možná.



BITY



802 NITOVACIE KLIESTE S KLÚČOM A PRUŽINOU

Pre hliníkové nity 3 - 4 - 5 mm,
pre oceľové 2,4 - 3 - 4 mm.

obj. kód
balenie
krabica

1050



5527 náhradné čeluste, 3 ks

UNIKÁTNY SŤAHOVACÍ SYSTÉM POMOCOU
3 ČELUSTÍ ZARUČÍ PEVNÉ DRŽANIE
HLINÍKOVÉHO, AKO AJ OCEĽOVÉHO NITU.

TELO KLIESTÍ VYROBENÉ Z PLECHU
LISOVANÉHO ZA STUDENA, HRúbKA 2,5 MM.

MODEL SA BEZ ÚPRAV VYRÁBA OD ROKU
1985, VYROBENÝCH TAKMER MILIÓN KUSOV.

TIETO ČELUSTE SÚ POUŽÍVANÉ VO VŠETKÝCH
BEARGRIP KLIESTOCH.

PATENTOVANÉ PREVEDENIE

BEARGRIP kliešte z roku 1985.

Možnosť ďalších farebných prevedí na požiadanie



Beargrip s.r.o.
Kollárova 88
03601 Martin
Slovakia
T: +421 434 003 605
F: +421 434 003 604
E: mail@beargrip.com
I: www.beargrip.com

810S NITOVACIE KLIESTE S KLÚČOM A PRUŽINOU

Pre hliníkové nity 2,4 - 3 - 4 mm,
pre ocelové 2,4 - 3 mm.



5527 náhradné čeluste, 3 ks

obj. kód
balenie
krabica

30001



810-0 NITOVACIE KLIESTE BEZ KLÚČA A PRUŽINY

Pre hliníkové nity 2,4 - 3 - 4 mm,
pre ocelové 2,4 - 3 mm.



5527 náhradné čeluste, 3 ks

obj. kód
balenie
krabica

1051



NITOVACIE KLIESTE

812 NITOVACIE KLIESTE - CHALLENGER S KLÚČOM A PRUŽINOU

Pre hliníkové nity 2,4 - 3 - 4 - 5 mm,
pre ocelové 2,4 - 3 - 4 mm.

obj. kód
balenie
krabica
31783



5527 náhradné čeluste, 3 ks



NAJDOKONALEJŠIE PREVEDENIE NA 4
VEĽKOSTI HLINÍKOVÝCH AJ OCEĽOVÝCH
NITOV.

PLASTOVÁ OCHRANA PROTI POŠKODENIU
MATERIÁLU V OBLASTI NITOVANIA.

MODEL SA BEZ ÚPRAV VYRÁBA OD ROKU
1995.

812LN NITOVACIE KLIESTE - COMPACT BEZ KLÚČA A PRUŽINY

Pre hliníkové nity 2,4 - 3 - 4 - 5 mm,
pre ocelové 2,4 - 3 - 4 mm.

obj. kód
balenie
krabica
31784

obj. kód
balenie
blister
31784



5527 náhradné čeluste, 3 ks



NAJDOKONALEJŠIE PREVEDENIE NA 4
VEĽKOSTI HLINÍKOVÝCH AJ OCEĽOVÝCH
NITOV.

NITOVACIE KLIESTE S PREDĽŽENÝM NOSOM,
VHODNÝM NA NITOVANIE ZAPUSTENÝCH
MIEST.



Beargrip s.r.o.
Kollárova 88
03601 Martin
Slovakia
T: +421 434 003 605
F: +421 434 003 604
E: mail@beargrip.com
I: www.beargrip.com



OCENENÝ
DIZAJNOVOU
KOMOROU
V HANNOVERI

AWARD FOR GOOD
INDUSTRIAL
DESIGN
HANNOVER

NAGRODA DLA
DOBRAPRZEMYSŁOWY
PROJEKT
HANNOVER

ПРЕМИЯ ЗА
ХОРОШЕЕ
ПРОМЫШЛЕННЫЕ
ДИЗАЙН HANNOVER

DÍJA JÓ
IPARI
TERVEZÉS
HANNOVER

822 SADA NITOV A NITOVACÍCH KLIESTÍ



5527 náhradné čeluste, 3 ks

obj. kód balenie PVC kufřík	sada obsahuje
31785	25 nitov 2,9 x 6
	25 nitov 3,8 x 6
	25 nitov 3,8 x 10

Praktické balenie obsahuje PVC kufřík so zámkom a držadlom, kliešte série 802 a hliníkové nity.



832 SADA NITOV A NITOVACÍCH KLIESTÍ



5527 náhradné čeluste, 3 ks

obj. kód balenie PVC kufřík	sada obsahuje
31786	25 nitov 2,9 x 6
	25 nitov 3,8 x 6
	25 nitov 3,8 x 10

Praktické balenie obsahuje PVC kufřík so zámkom a držadlom, kliešte série 812 a hliníkové nity.



NITOVACIE KLIESTE

814 NITOVACIE MATICOVÉ KLIŠTE, M4 - M5 - M6

Vhodné pre všetky závitové vložky z hliníka M4 - M5 - M6.



obj. kód
balenie
blister
31787

Konštrukcia tela vychádza z modelovej rady 812, s úpravou pre maticové nity M4 - M5 - M6.

REGULOVATEĽNÁ VÝŠKA ZLISOVANIA.

834 SADA MATICOVÝCH NITOV A KLIŠTÍ

obj. kód balenie PVC kufrík	sada obsahuje
299	25 maticových nitov M4
	20 maticových nitov M5
	20 maticových nitov M6

Praktické balenie obsahuje PVC kufrík so zámkom a držadlom, kliešte série 814 a hliníkové nity.

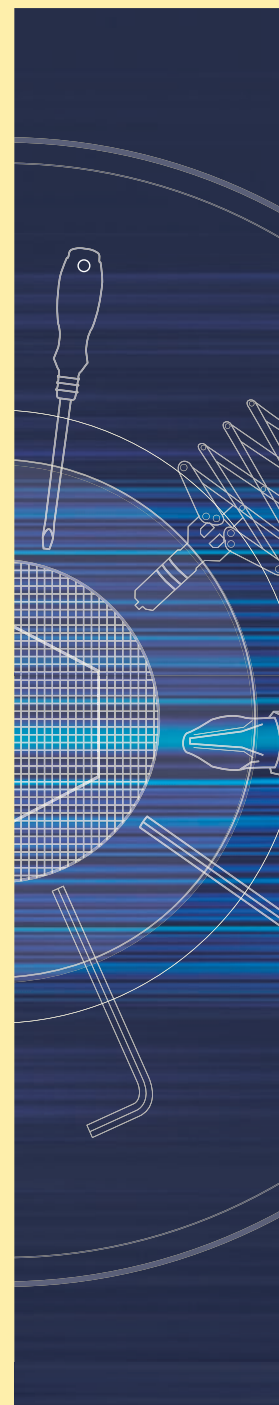

Beargrip s.r.o.
Kollárova 88
03601 Martin
Slovakia
T: +421 434 003 605
F: +421 434 003 604
E: mail@beargrip.com
I: www.beargrip.com

805 STD NITOVACIE KLIESTE S KLÚČOM NA HLINÍKOVÉ NITY

Pre hliníkové nity 2,4 - 3 - 4 - 5 - 6 mm a ocelové 2,4 - 3 - 4 - 5 mm.



5527 náhradné čeluste, 3 ks

obj. kód
16519

VHODNÉ PRE NITOVANIE VO VERTIKÁLNYCH POLOHÁCH.



BEARGRIP kliešte z roku 1990.

805 AC NITOVACIE KLIESTE S KLÚČOM NA HLINÍKOVÉ A OCEĽOVÉ NITY, ANTI-CHOC

Pre hliníkové nity 2,4 - 3 - 4 - 5 - 6 mm a ocelové 2,4 - 3 - 4 - 5 mm.



5527 náhradné čeluste, 3 ks

obj. kód
2970

VHODNÉ PRE NITOVANIE VO VERTIKÁLNYCH POLOHÁCH.

NAJDOKONALEJŠIE PREVEDENIE NOŽNICOVÝCH KLIESTÍ,
SO ŠTYRMI TLMIACIMI ZÓNAMI - ABSOLÚTNE ŠETRNÉ
K RUKÉ OBSLUHY.

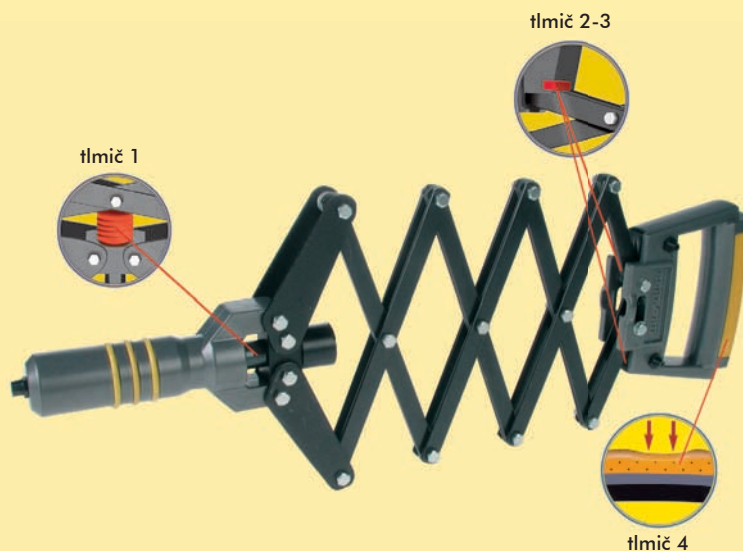

MEDZINÁRODNÝ PATENT

NITOVACIE KLIESTE

815 AC NITOVACIE KLIESTE S KLÚČOM Z HLINÍKA A OCELE, ANTI-CHOC



5527 náhradné čeluste, 3 ks

Pre hliníkové nity 3 - 4 - 5 - 6 mm,
pre ocelové 2,4 - 3 - 4 - 5 mm.

obj. kód
balenie
krabica
17925

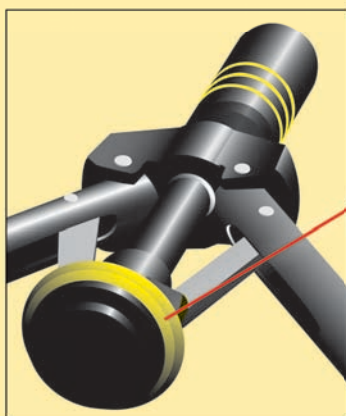

VHODNÉ PRE NITOVANIE V HORIZONTÁLNYCH POLOHÁCH.

ZBERNÁ NÁDOBA.

OBSAHUJE TLMIČ- ABSOLÚTNE ŠETRNÉ K RUKÉ A RAMENU.

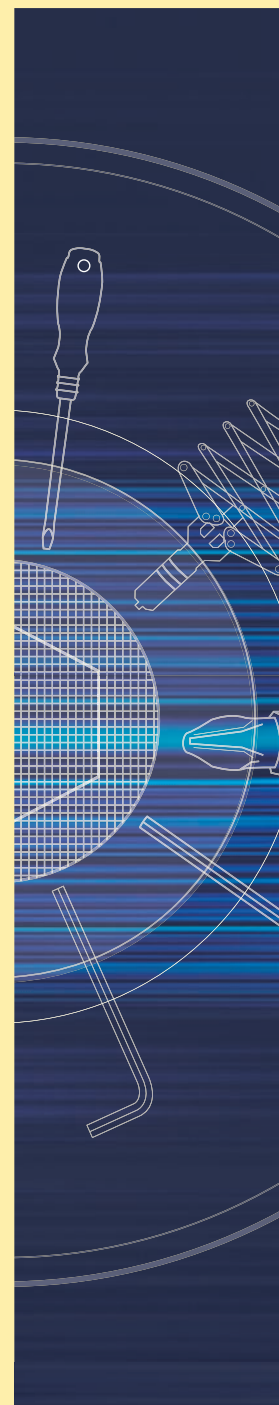

Beargrip s.r.o.
Kollárova 88
03601 Martin
Slovakia
T: +421 434 003 605
F: +421 434 003 604
E: mail@beargrip.com
I: www.beargrip.com

MATICOVÉ NITY

obj. kód balenie krabička	veľkosť	Ø mm	ks
31788	M4	12,5	10
31789	M5	15	10
31790	M6	15,5	10



NITY S FAREBNÝM ODLÍŠENÍM



obj. kód balenie bulk	obj. kód balenie krabička	Ø	L2 mm	K3 mm
31791	30922	2,9	krátky 6 mm - 1/4"	2,5 - 4,0
31792	30923		stredný 9 mm - 3/8"	4,0 - 6,0
31793	30921		dlhý 12 mm - 1/2"	6,0 - 10,0

obj. kód balenie bulk	obj. kód balenie krabička	Ø	L2 mm	K3 mm
31794	30925	3,15 - 1/8"	krátky 6 mm - 1/4"	2,5 - 4,0
31795	30926		stredný 9 mm - 3/8"	4,0 - 6,0
31796	30924		dlhý 12 mm - 1/2"	6,0 - 10,0

obj. kód balenie bulk	obj. kód balenie krabička	Ø	L2 mm	K3 mm
31797	30929	3,8 - 5/32"	krátky 6 mm - 1/4"	2,5 - 4,5
31798	30927		stredný 9 mm - 3/8"	5,0 - 7,0
31799	30928		dlhý 12 mm - 1/2"	7,0 - 9,5

obj. kód balenie bulk	obj. kód balenie krabička	Ø	L2 mm	K3 mm
31800	30932	4,8 - 3/16"	krátky 6 mm - 1/4"	2,5 - 3,5
31801	30930		stredný 9 mm - 3/8"	4,0 - 7,0
31802	30931		dlhý 12 mm - 1/2"	7,0 - 9,0

DĹŽKA NITU

JE VEĽMI JEDNODUCHÉ NÁJŠŤ SPRÁVNE NITOVACIE KLIESTE

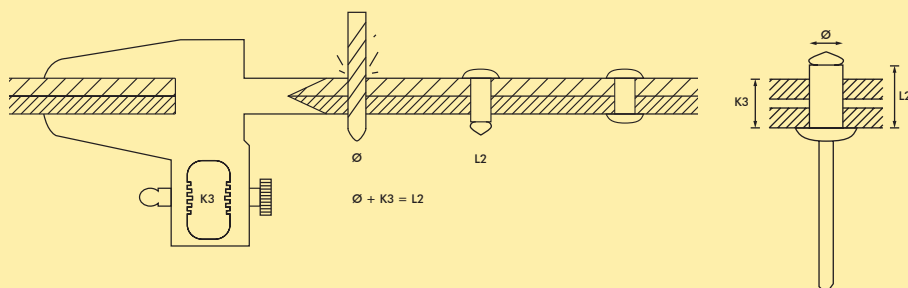

NITOVACIE KLIESTE



24091 profesionálny uvoľňovač skrutiek v spreji

Zákazková výroba BEARGRIP možná

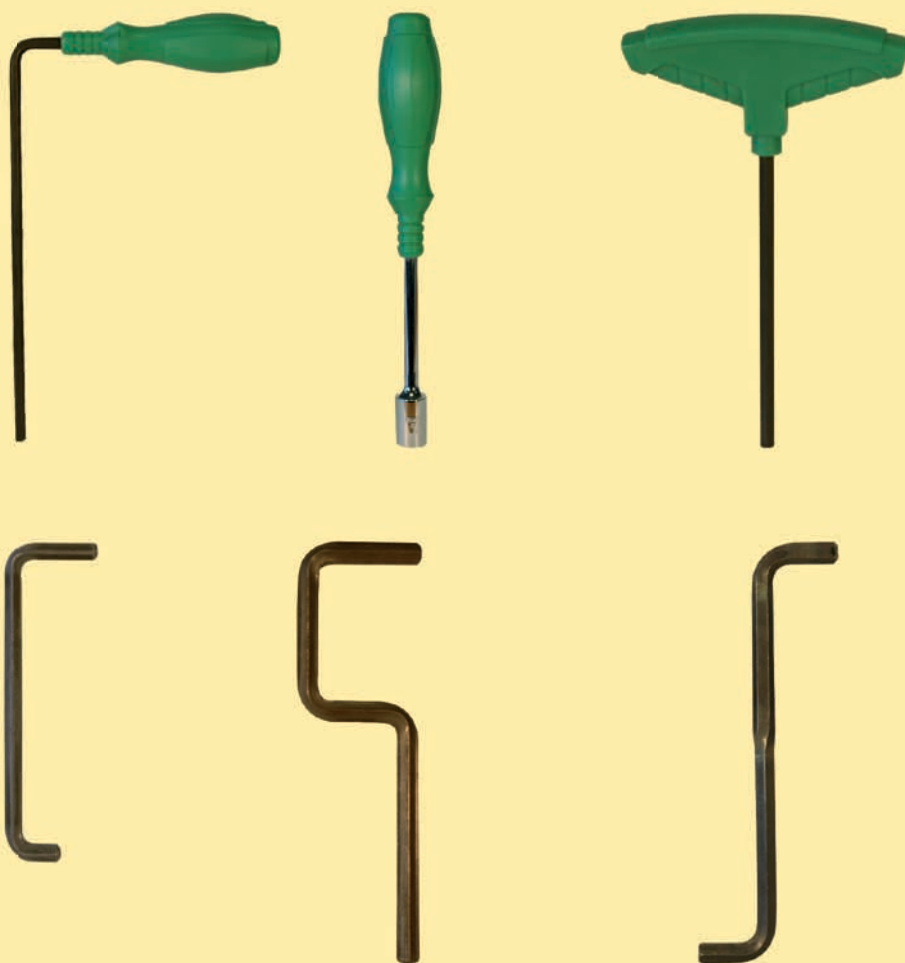

 **BEARGRIP**[®]
Tool Mfg. Co. Made in Slovakia



Beargrip s.r.o.

Kollárova 88

03601 Martin

Slovakia

T: +421 434 003 605

F: +421 434 003 604

E: mail@beargrip.com

I: www.beargrip.com